

Legionnaires' disease

Part 2: The control of legionella bacteria in hot and cold water systems



This guidance is for dutyholders, which includes employers, those in control of premises and those with health and safety responsibilities for others, to help them comply with their legal duties. These include identifying and assessing sources of risk, preparing a scheme to prevent or control risk, implementing, managing and monitoring precautions, keeping records of precautions and appointing a manager responsible for others.

The guidance gives practical advice on the legal requirements of the Health and Safety at Work etc Act 1974, the Control of Substances Hazardous to Health Regulations 2002 concerning the risk from exposure to *Legionella* and guidance on compliance with the relevant parts of the Management of Health and Safety at Work Regulations 1999.

HSG274 Part 2
Published 2014

Contents

| | |
|--|-----------|
| Introduction | 1 |
| Types and application of hot and cold water systems | 8 |
| Water system design and commissioning | 18 |
| Operation and inspection of hot and cold water systems | 25 |
| Water treatment and control programmes for hot and cold water systems | 34 |
| Microbiological monitoring | 40 |
| Cleaning and disinfection | 42 |
| Shared premises and residential accommodation: Landlords | 45 |
| Special considerations for healthcare and care homes | 48 |
| Appendix 2.1 Legionella risk assessment | 53 |
| Appendix 2.2 Legionella written control scheme | 55 |
| Appendix 2.3 Action to take if there is an outbreak of legionellosis | 56 |
| Appendix 2.4 Example of sentinel points in a simple hot water system (HWS) | 57 |
| Appendix 2.5 Example of sentinel points in large complex hot water system (HWS) | 58 |
| Glossary | 59 |
| References | 62 |
| Further sources of advice | 65 |
| Acknowledgements | 65 |
| Further information | 65 |

Introduction

1 This guidance is for dutyholders, which includes employers, those in control of premises and those with health and safety responsibilities for others, to help them comply with their legal duties. It gives practical guidance on how to assess and control the risks due to legionella bacteria.

2 Any water system that has the right environmental conditions could potentially be a source for legionella bacteria growth. There is a reasonably foreseeable legionella risk in your water system if:

- water is stored or re-circulated as part of your system;
- the water temperature in all or some part of the system may be between 20–45 °C;
- there are deposits that can support bacterial growth, such as rust, sludge, scale and organic matter;
- it is possible for water droplets to be produced and, if so, if they can be dispersed;
- it is likely that any of your employees, contractors, visitors etc could be exposed to any contaminated water droplets.

Health and safety law

3 *Legionnaires' disease: The control of legionella bacteria in water systems. Approved Code of Practice*¹ gives specific information on the health and safety law that applies. In brief, general duties under the Health and Safety at Work etc Act 1974 (the HSW Act)² extend to risks from legionella bacteria, which may arise from work activities. The Management of Health and Safety at Work Regulations 1999 provide a broad framework for controlling health and safety at work (see www.hse.gov.uk/risk for more information). More specifically, the Control of Substances Hazardous to Health Regulations 2002 (COSHH)³ provide a framework of duties designed to assess, prevent or control the risks from hazardous substances, including biological agents such as legionella, and take suitable precautions.

4 The essential elements of COSHH are:

- risk assessment;
- prevention of exposure or substitution with a less hazardous substance if this is possible, or substitute a process or method with a less hazardous one;
- control of exposure where prevention or substitution is not reasonably practicable;
- maintenance, examination and testing of control measures, eg automatic dosing equipment for delivery of biocides and other treatment chemicals;
- provision of information, instruction and training for employees;
- health surveillance of employees (where appropriate, and if there are valid techniques for detecting indications of disease) where exposure may result in an identifiable disease or adverse health effect.

5 Under general health and safety law, dutyholders including employers or those in control of premises, must ensure the health and safety of their employees or others who may be affected by their undertaking. They must take suitable precautions to prevent or control the risk of exposure to legionella. They also need to either understand, or appoint somebody competent who knows how to identify and assess sources of risk, manage those risks, prevent or control any risks, keep records and carry out any other legal duties they may have.

Other relevant legislation

6 Employers must be aware of other legislation they may need to comply with, which includes the Notification of Cooling Towers and Evaporative Condensers Regulations 1992;⁴ Reporting of Injuries, Diseases and Dangerous Occurrences Regulations 2013 (RIDDOR);⁵ the Safety Representatives and Safety Committees Regulations 1977 and the Health and Safety (Consultation with Employees) Regulations 1996.⁶

Notification of Cooling Towers and Evaporative Condensers Regulations 1992

7 These Regulations require employers to notify the local authority, in writing, if they operate a cooling tower or evaporative condenser and include details about where they are located. The Regulations also require notification when such devices are no longer in use. Notification forms are available from your local environmental health department.

Reporting of Injuries, Diseases and Dangerous Occurrences Regulations 2013 (RIDDOR)

8 These regulations require employers and those in control of premises to report accidents and some diseases that arise out of or in connection with work to HSE. Cases of legionellosis are reportable under RIDDOR if a medical practitioner notifies the employer; and the employee's current job involves work on or near cooling systems that are located in the workplace and use water; or work on water service systems located in the workplace, which are likely to be a source of contamination. For more information, see HSE guidance at www.hse.gov.uk/riddor/index.htm.

The Safety Representatives and Safety Committees Regulations 1977 and the Health and Safety (Consultation with Employees) Regulations 1996

9 These regulations require employers to consult trade union safety representatives, other employee representatives, or employees where there are no representatives, about health and safety matters. This includes changes to the work that may affect their health and safety, arrangements for getting competent help, information on the risks and controls, and the planning of health and safety training.

Identify and assess sources of risk

10 Carrying out a legionella risk assessment and ensuring it remains up to date is required under health and safety law and is a key duty when managing the risk of exposure to legionella bacteria. In conducting the assessment, the dutyholder must appoint a competent person or persons, known as the responsible person(s), to help them meet their health and safety duties, ie take responsibility for managing the control scheme. If the necessary competence, knowledge and expertise does not exist, there may be a need to appoint someone externally (see paragraphs 16-22).

11 The responsible person(s) appointed to take day-to-day responsibility for managing risks in their business will need to understand the water systems, any equipment associated with the system, and all its constituent parts. They should be able to identify if the water systems are likely to create a risk from exposure to legionella bacteria by assessing if:

- water is stored or re-circulated in the system;
- the water temperature in all or some parts of the system may be between 20–45 °C;
- there are deposits that support bacterial growth, including legionella, such as rust, sludge, scale, organic matter and biofilms;
- it is possible for water droplets to be produced and, if so, whether they can be dispersed;

- it is likely that any of your employees, contractors, visitors, the public etc could be exposed to contaminated water droplets.

12 The practical risk assessment should include a site survey of all the water systems and consider other health and safety aspects of undertaking such investigations, eg working at height or in confined spaces or the need for permits-to-work when doing this.

13 Appendix 2.1 provides information on the key requirements when assessing the risks associated with any water systems. Further information is also available in BS 8580 *Water quality. Risk assessments for Legionella control. Code of Practice*⁷ and in The Water Management Society's *Guide to risk assessment for water services*.⁸ In summary, the risk assessment should consider and evaluate:

- clear allocation of management responsibilities;
- competence and training of key personnel;
- a description of the water system, including an up-to-date schematic diagram;
- an evaluation of the risk;
- safe operating procedures for the water system, including controls in place to control risks;
- monitoring, inspection and maintenance procedures;
- results of monitoring, inspection and any checks carried out;
- limitations of the legionella risk assessment;
- arrangements to review the risk assessment regularly and particularly when there is reason to suspect it is no longer valid.

Info box: Schematic diagram

A schematic diagram is a simplified but accurate illustration of the layout of the water system, including parts temporarily out of use. While providing only an indication of the scale, it is an important tool as it allows any person who is not familiar with the system to understand quickly and easily their layout, without any specialised training or experience. These are not formal technical drawings but show what the systems comprise of, illustrating plant and equipment, including servicing and control valves, any components potentially relevant to the legionella risk, including outlets, strainers and filters or parts that are out of use.

14 If the risk assessment concludes there is no reasonably foreseeable risk or the risks are insignificant and are managed properly to comply with the law, the assessment is complete. Although no further action may be required at this stage, existing controls must be maintained. The assessment of risk is an ongoing process and not merely a paper exercise. Dutyholders should arrange to review the assessment regularly and specifically when there is reason to suspect it is no longer valid. An indication of when to review the assessment and what to consider should be recorded and this may result from, eg:

- a change to the water system or its use;
- a change to the use of the building where the system is installed;
- new information available about risks or control measures;
- the results of checks indicating that control measures are no longer effective;
- changes to key personnel;
- a case of legionnaires' disease/legionellosis associated with the system.

15 Communication is a key factor in the risk assessment process. The risk needs to be identified and communicated to management to allow them to prioritise remedial actions to control it.

Managing the risk

16 Inadequate management, lack of training and poor communication can be contributory factors in outbreaks of legionnaires' disease. It is important that those people involved in assessing risk and applying precautions are competent, trained and aware of their responsibilities.

17 The dutyholder should specifically appoint a competent person or persons to take day-to-day responsibility for controlling any identified risk from legionella bacteria. It is important for the appointed person, known as the responsible person(s), to have **sufficient authority, competence and knowledge of the installation** to ensure all operational procedures are carried out in a timely and effective manner.

18 The responsible person(s) appointed to implement the control measures and strategies should be suitably informed, instructed and trained and their suitability assessed. Regular refresher training should be given and the responsible person(s) should have a clear understanding of their role and the overall health and safety management structure and policy in the organisation.

19 If a dutyholder is self-employed or a member of a partnership, and is competent, they may appoint themselves. Many businesses can develop the necessary expertise in house and are well equipped to manage health and safety themselves. However, if there are some things they are not able to do, it is important to get external help. If there are several people responsible for managing risks, eg because of shift-work patterns, the dutyholder needs to make sure that everyone knows what they are responsible for and how they fit into the overall risk management of the system.

20 Identifying and deciding what help is needed is very important but it is the responsibility of the dutyholder to ensure those appointed to carry out the tasks given to them have adequate information and support.

21 Dutyholders can use specialist contractors to undertake aspects of the operation, maintenance and control measures required for their water system. While these contractors have legal responsibilities, the ultimate responsibility for the safe operation of the water system rests with the dutyholder. It is important they are satisfied that any contractors employed are competent to carry out the required tasks and that the tasks are carried out to the required standards. The contractor should inform the dutyholder of any risks identified and how the system can be operated and maintained safely.

22 There are a number of external schemes to help you with this, such as the Legionella Control Association's *A Recommended Code of Conduct for Service Providers*.⁹

Preventing or controlling the risk

23 First, consider whether the risk of legionella can be prevented by considering the type of water systems needed. Where the risk cannot be prevented, a course of action must be devised to manage the risk by implementing effective control measures. The written scheme should be specific and tailored to the systems covered by the risk assessment. Appendix 2:2 summarises the key information, which should include the following precautions:

- ensuring the release of water spray is properly controlled;
- avoiding conditions that support growth of microorganisms, including legionella;

- ensuring water cannot stagnate anywhere in the system by regular movement of water in all sections of the systems and by keeping pipe lengths as short as possible, and/or removing redundant pipework and deadlegs;
- avoiding using materials that harbour bacteria and other microorganisms or provide nutrients for microbial growth (the *Water Fittings and Materials Directory*¹⁰ lists fittings, materials, and appliances approved for use on the UK Water Supply System by the Water Regulations Advisory Scheme. Those approved are tested against BS 6920);¹¹
- keeping the system and the water in it clean;
- treating water to either control the growth of microorganisms, including legionella, or limit their ability to grow;
- monitoring any control measures applied;
- keeping records of these and other actions taken, such as maintenance and repair work.

Record keeping

24 Where there are five or more employees, the significant findings of the risk assessment must be recorded. If there less than five employees, there is no requirement to record anything although it is useful to keep a written record.

25 Records must be retained for the period they remain current and for at least two years afterwards, with the exception of records kept for monitoring and inspection, which should be kept for at least five years. It may be helpful to keep training records of employees; records of the work of external service providers, such as water treatment specialists; and information on other hazards, eg chemical safety data sheets.

26 Records, either written or electronic, should contain accurate information about who did the work and when it was carried out. All records should be signed, verified or authenticated by a signature or other appropriate means. Records should include details of the:

- person or people responsible for conducting the risk assessment, managing, and implementing the written scheme;
- significant findings of the risk assessment;
- written control scheme and details of its implementation;
- details of the state of operation of the system, ie in use/not in use;
- results of any monitoring, inspection, test or check carried out, the dates and any resulting corrective actions, as defined in the written scheme of precautions, such as:
 - results of chemical and microbial analysis of the water;
 - water treatment chemical usage;
 - inspections and checks on the water treatment equipment to confirm correct operation;
 - inspections and checks on the water system components and equipment to confirm correct and safe operation;
 - records of maintenance to the water system components, equipment and water treatment system;
 - the cleaning and disinfection procedures and the associated reports and certificates.

Types and application of hot and cold water systems

2.1 Hot and cold water systems are those that supply water for domestic purposes (drinking, cooking, food preparation, personal hygiene and washing). This section provides information on the different types, design and use of systems available to supply hot and cold water services.

2.2 Water systems in high risk locations (such as healthcare premises, care homes, residential homes and other situations where those exposed to the water systems are likely to be at high risk of infection) need particular consideration. The risk assessment should consider both the relative risks of legionella and scalding. See paragraphs 2.152–2.168, www.hse.gov.uk/healthservices/ and *Health and safety in care homes*¹² for more information for care settings. Healthcare premises should refer to *Water systems: Health Technical Memorandum 04–01*¹³ (for England and Wales), or to *Scottish Health Technical Memorandum 04–01*¹⁴ (for Scotland).

2.3 Those who provide residential accommodation or who are responsible for the water systems in premises must assess the risk from exposure to legionella to residents, tenants, guests and customers and implement control measures, if appropriate. It is also increasingly common for there to be several dutyholders in one building who may also have responsibilities for assessing and managing the risk from legionella. See paragraphs 2.138–2.151 for specific guidance.

2.4 Within hot and cold water systems, the risk areas that support growth of microorganisms, including legionella, are controllable with good design, operation, maintenance and water system management and include:

- the base of the water heater and storage vessel, particularly where incoming cold water reduces the temperature of the water within the vessel and where sediment collects and is distributed throughout the system;
- where optimum temperatures for microbial growth and stagnation occur, eg dead legs, capped pipes (dead ends), infrequently used outlets and areas of the system where there is poor circulation;
- where incoming cold water temperatures are above 20 °C, or there are areas within the cold water system that are subject to heat gain and areas of stagnation where there are deposits to support growth.

Safe operation and control measures

2.5 This guidance provides detailed information on types of water system, design considerations and commissioning systems to ensure risks from exposure to legionella are minimised or reduced as far as is reasonably practicable. There is also guidance on operational and control measures.

2.6 Temperature control is the traditional strategy for reducing the risk of legionella in water systems. Cold water systems should be maintained, where possible, at a temperature below 20 °C. Hot water should be stored at least at 60 °C and distributed so that it reaches a temperature of 50 °C (55 °C in healthcare premises) within one minute at the outlets. For most people, the risk of scalding at this temperature is low. However, the risk assessment should take account of susceptible 'at risk' people including young children, people who are disabled or elderly and to those with sensory loss for whom the risk is greater.

2.7 In addition to temperature control, eg in more complex systems such as large healthcare facilities, additional measures that encourage the regular movement of water are often used to manage the risk from legionella in water systems. The exact techniques may vary significantly in different water systems and operating conditions. Paragraphs 2.80–2.118 give further guidance on the use of water treatment techniques and control programmes.

2.8 The cleanliness of the system must be maintained, as legionella bacteria are more likely to grow in a system fouled with deposits. In hard water areas, softening of the cold water supply to the hot water distribution system should be considered to reduce the risk of scale being deposited at the base of the calorifier and heating coils, and to reduce the potential for scale build-up within the system pipework and components – see paragraphs 2.72–2.73. There is further guidance on cleaning and disinfection techniques and requirements for hot and cold water systems in paragraphs 2.126–2.137.

Hot and cold water systems

2.9 There are many types of water systems supplying hot and cold water services and these vary depending on the size and complexity of the building. Figures 2.1–2.11 are representative diagrams illustrating the range of different types of system or components and are not technical or design installation guides. Combinations and variations are possible, but these systems are broadly grouped as:

- **smaller hot and cold water systems**, eg directly fed mains cold water to outlets with localised point of use (POU) water heaters;
- **gravity-fed cold water systems** incorporating storage tanks (cisterns) and larger water heaters (calorifiers) for the provision of hot water. Hot water systems (HWS) typically operate without secondary hot water recirculation in smaller premises and with recirculation in larger premises. Cold water distribution systems (CWDS) do not normally recirculate cold water and require outlets to be operated to prevent stagnation in adjacent parts of the system;
- **pressurised systems** that can be directly mains fed or incorporate storage and booster pumps supplying cold water and unvented water heaters with or without secondary recirculation.

Smaller hot and cold water systems

2.10 These systems are typically found in smaller buildings such as domestic dwellings and small office buildings where cold water outlets are fed directly from the water supply without storage. Combination boilers or instantaneous water heaters (see Figure 2.1) provide hot water directly from the cold water supply by heating the water as it passes through the heater. These units supply continuous hot water at a rate that is usually limited by their power rating. High flow rates through the units can result in warm water leaving the heater before reaching the target temperature.

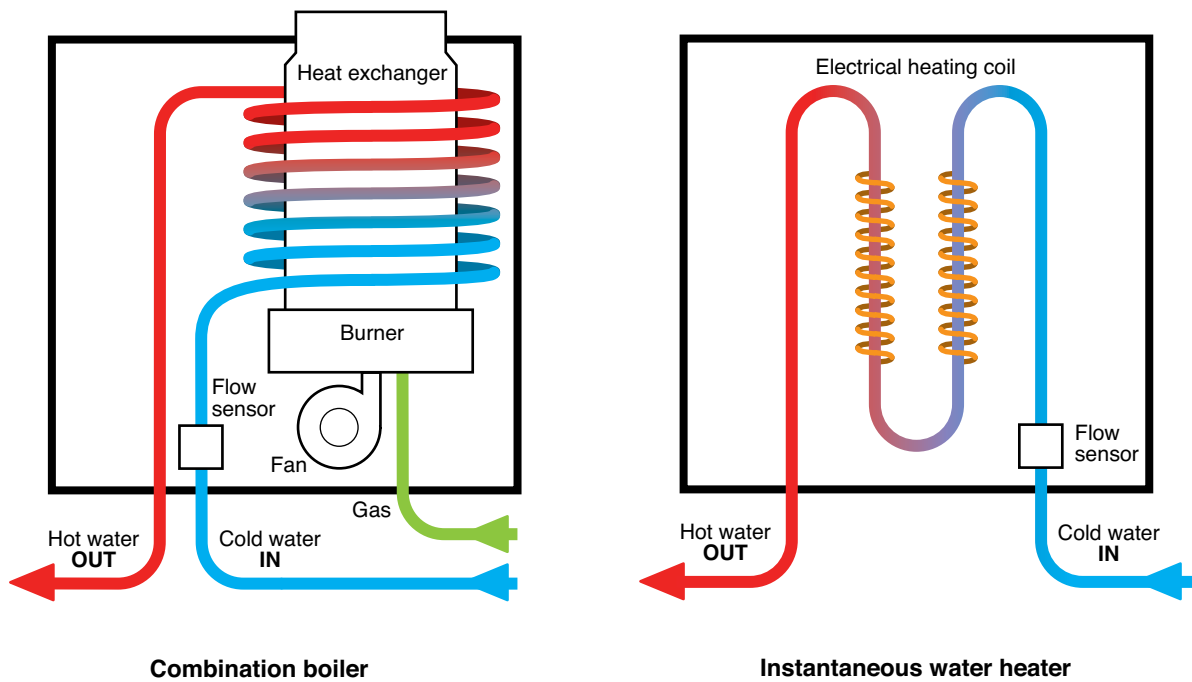

Figure 2.1 Non-storage water heaters

2.11 Low storage volume POU water heaters are those that store no more than 15 litres of hot water (see Figure 2.2). These systems generally heat water to a set point that is often variable via a simple dial on the unit. These systems deliver a small volume of stored hot water before they need to be left to recover and bring the temperatures back to the set point.

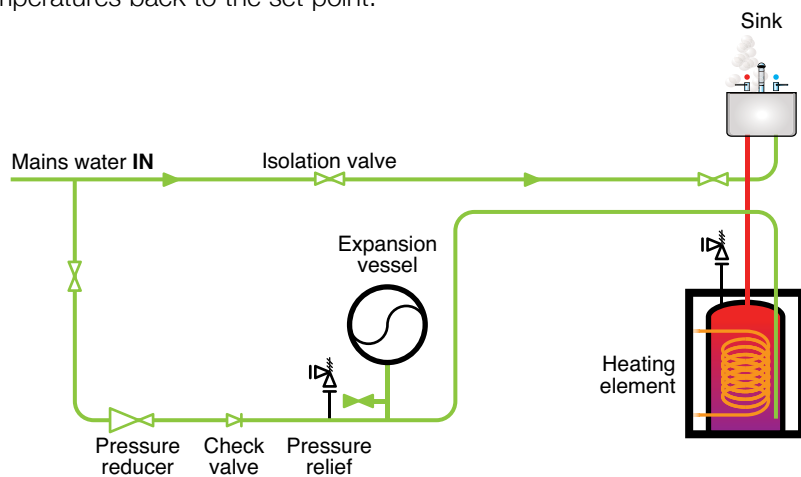

Figure 2.2 Low storage volume POU water heater

2.12 Combination water heaters store a volume of cold water (ranging from 10–200 litres) above the hot water storage unit (ranging from 15–150 litres). In these units (see Figure 2.3) the cold water header tank feeds the hot water storage vessel as hot water is drawn from the system on demand. The cold water header tank is topped up directly from the cold water supply, usually via a float-operated valve. The combination water heater is usually fitted with an expansion pipe so that any expanding hot water returns into the cold water header tank. Expansion may also occur by the cold feed pipe.

2.13 The design of a combination water heater may allow hot water to enter the cold water space. The Water Supply (Water Fittings) Regulations 1999,¹⁵ the Scottish Water Byelaws 2004,¹⁶ and BS 3198 *Specification for copper hot water storage combination units for domestic purposes*¹⁷ recognise this and permit a maximum cold water storage temperature of 25 °C where it is serving other domestic outlets or 38 °C when serving the hot water vessel only. Careful consideration should be given to managing the risks from these types of systems and this should be reflected in the risk assessment. The thermostat should be set to as close to 60 °C as is practicable without exceeding it and hot water at the outlets should be at a minimum of 50 °C; correct setting of the thermostat and regular water usage is necessary to keep the temperature increase in the cold water to a minimum. Where this is not possible, eg during periods of low usage such as overnight or at weekends, fitting a timer which switches off the immersion heater may prove effective. The timer should be set to switch the immersion heater on again in time to ensure the water is heated sufficiently to achieve microbial control before use.

2.14 Electrical immersion heaters usually heat combination heaters but some units incorporate internal coils for primary boiler heating circuits.

2.15 In some combination units, the header tank is split into two sections: one feeding the water heater below and the other supplying cold water to the closed heating system. Possible cross-contamination and poor temperatures should be considered as part of the risk assessment.

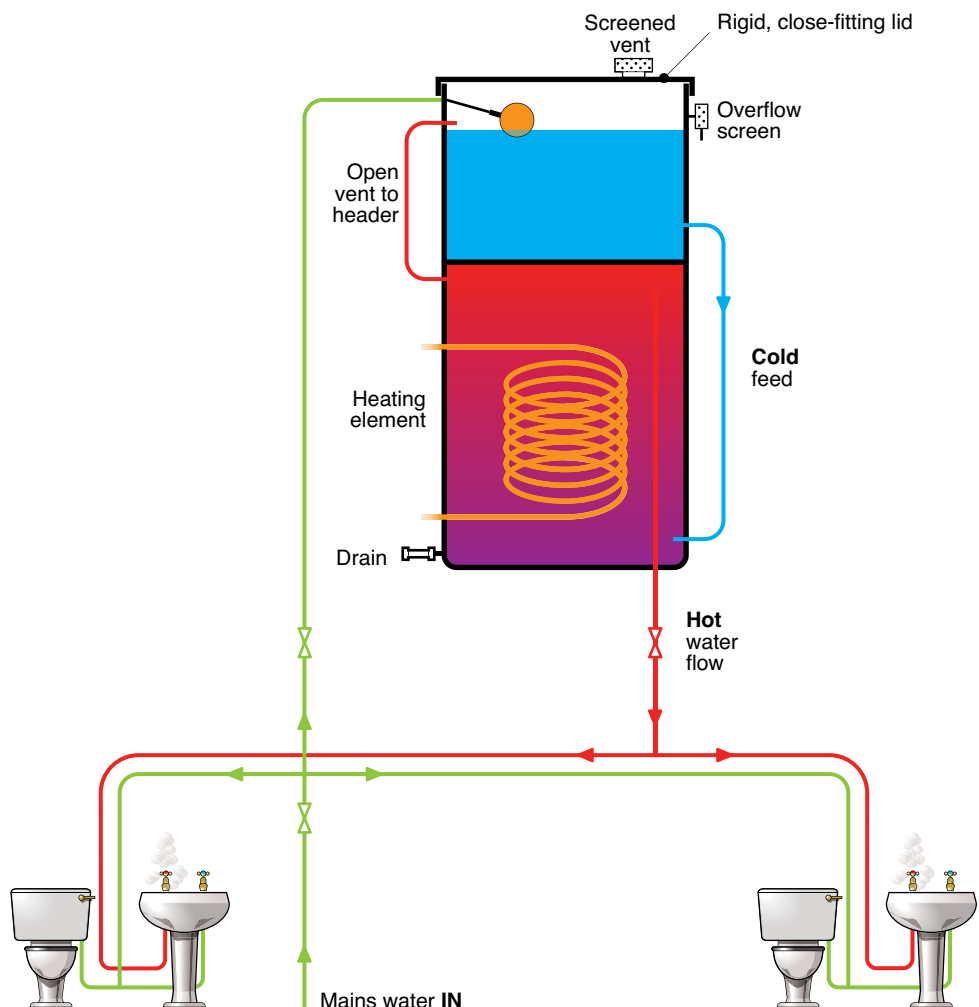

Figure 2.3 Combination water heater

Gravity-fed water systems

Gravity system without recirculation

2.16 Gravity systems without recirculation (Figure 2.4) are generally installed in domestic dwellings and small buildings. Cold water enters the building from a rising main and is stored in a cold water tank. The cold water tank provides backflow protection to the mains supply and a stable pressure and reserve in the system if the mains pressure fails or demand exceeds the capacity of the mains supply. Cold water from the tank is fed to the calorifier (hot water cylinder) where it is heated and drawn via pipes that branch to sinks, washbasins, baths, showers etc. In contrast to recirculating systems, the water only flows when it is being used and is usually allowed to become cool in the pipes after use.

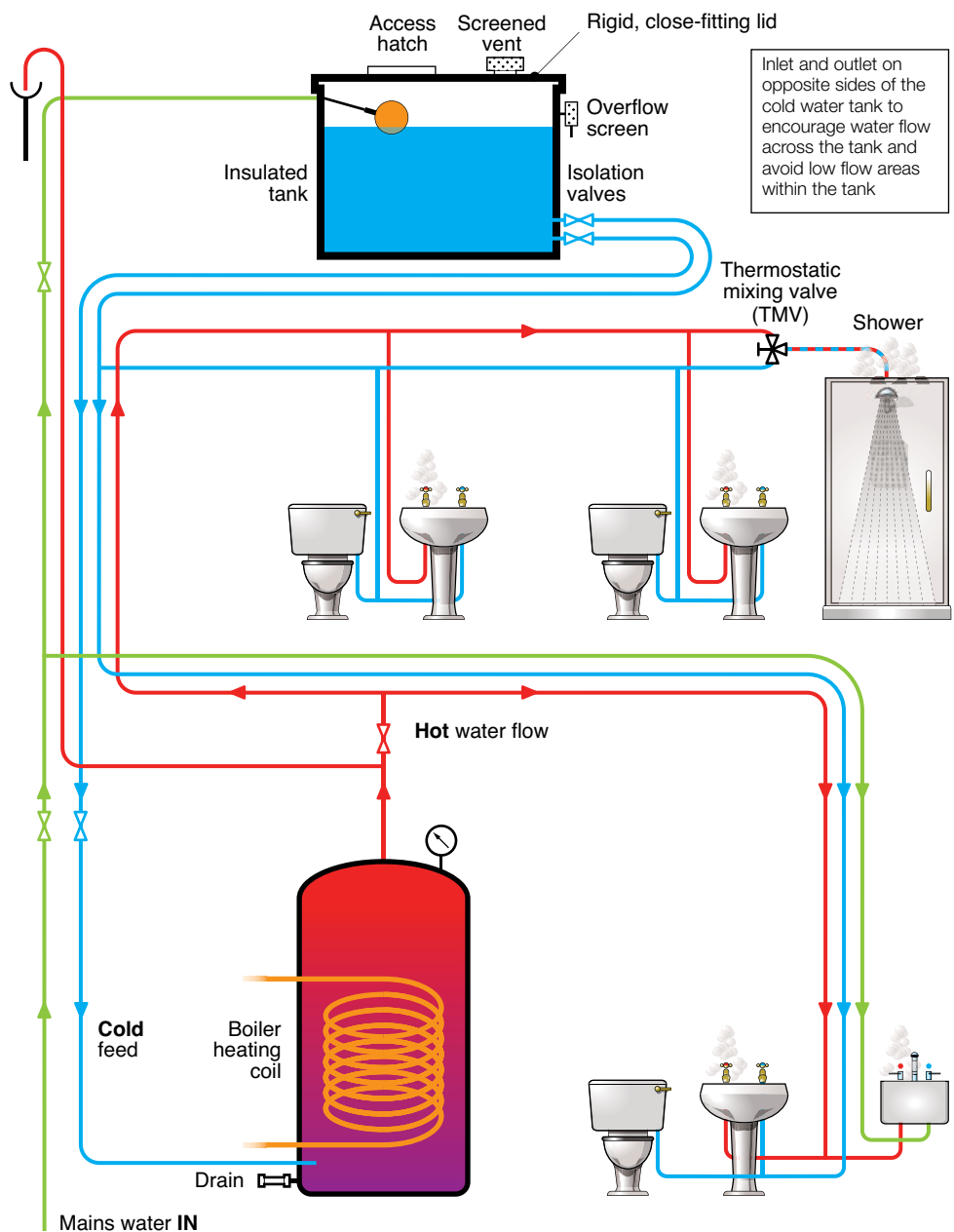

Figure 2.4 Gravity-fed hot and cold water system without recirculation

Gravity system with recirculation

2.17 Gravity systems with recirculation are typically installed in larger buildings such as commercial premises (Figure 2.5). Cold water enters the building from a rising main and is stored in a cold water storage tank or tanks. The tank provides backflow protection to the mains supply and a stable pressure in the system; it also provides a reserve if the mains pressure fails or demand exceeds the capacity of the mains supply. Cold water from this storage tank is fed to the calorifier. Cold water from this storage tank is fed to the calorifier.

2.18 There is a continuous circulation of hot water from the calorifier around the distribution circuit and back to the calorifier by means of one or more pumps, usually installed on the return to the calorifier, but it can be on the flow. This is to ensure that hot water is quickly available at any of the taps, independent of their distance from the calorifier and reduces the risk of localised temperature fluctuations. The circulation pump is sized to compensate for the heat losses from the distribution circuit so that the return temperature to the calorifier is not less than 50 °C.

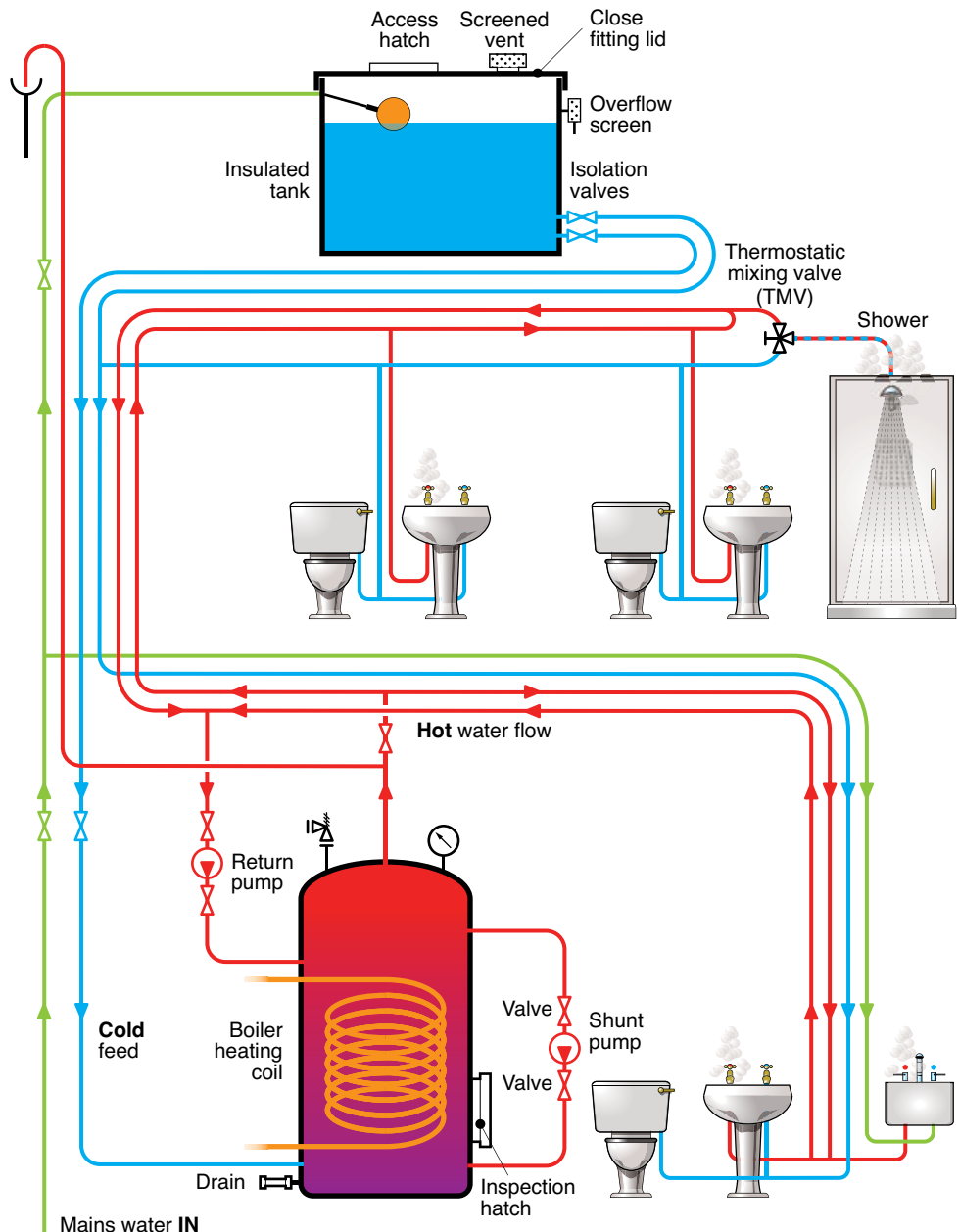

Figure 2.5 Gravity-fed system with recirculation

2.19 The pump has little effect on the pressure at the tap, which is determined by the relative height of the storage tank. The expansion of water as it is heated within the system is accommodated by a slight rise in the levels of the tank and vent pipe. The vent pipe should be directed into a separate tundish/drain which discharges at a safe and visible point and acts as a warning pipe. Discharge into the cold water storage tank is not advised as this can result in warm storage water temperatures and increase the risk of microbial growth. In the cold water system, water is fed by gravity directly from the cold water storage tank to the points of use without recirculation.

Pressurised systems

2.20 These systems are fed directly by a pressurised supply (sometimes via a break tank and booster set) connected to the calorifier, water heater or heat exchanger (Figure 2.6). In these systems, water expands when heated, requiring an expansion vessel, safety temperature and pressure relief valve (in a pressurised hot water system there is no open vent to a high level). Hot water distribution can be a recirculating or non-recirculating system.

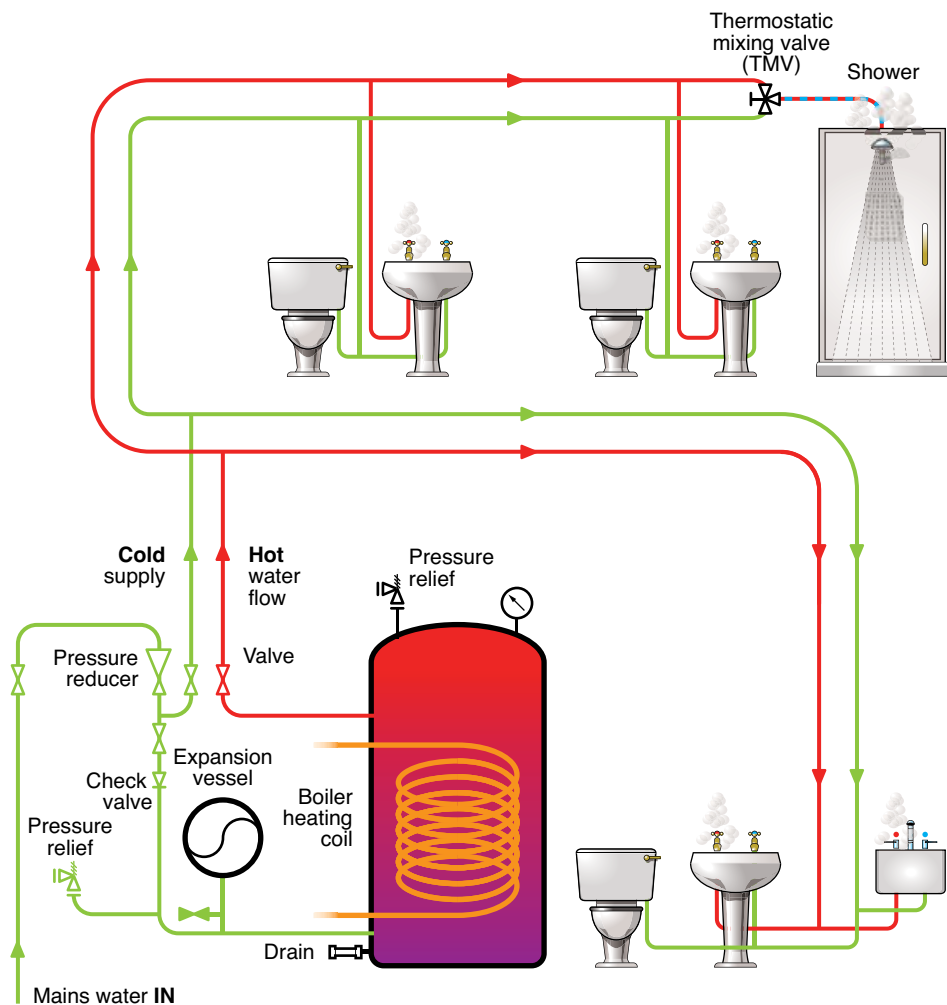

Figure 2.6 Pressurised mains-fed system with non-recirculating hot water distribution

2.21 Larger systems or those that require higher pressures to reach the top of the building often include break tanks and booster pumps, in place of direct mains water, that subsequently feed the water heater.

Hot water heaters: Calorifiers and hot water cylinders

2.22 There are varieties of hot water heaters available that comply with the Water Supply (Water Fitting) Regulations 1999 and for Scotland, the Scottish Water Byelaws 2004. The specification will depend on the size and usage of the system.

2.23 Hot water heaters are water storage vessels heated by:

- primary heating circuits of low pressure hot water or steam which is passed through a heat exchanger inside the vessel;
- gas or oil flame, directly;
- electricity, normally by means of an electric immersion heater within the vessel; or
- an external heat exchanger (sometimes returning to a holding 'buffer' vessel).

Direct-fired (gas) water heaters

2.24 Characteristic of this type of design is heating from below which avoids the reduced temperature areas found in indirect heating calorifiers; they also have lower storage volumes and even temperature distribution (Figure 2.7). This type of water heater has been shown to have a low incidence of colonisation by legionella.

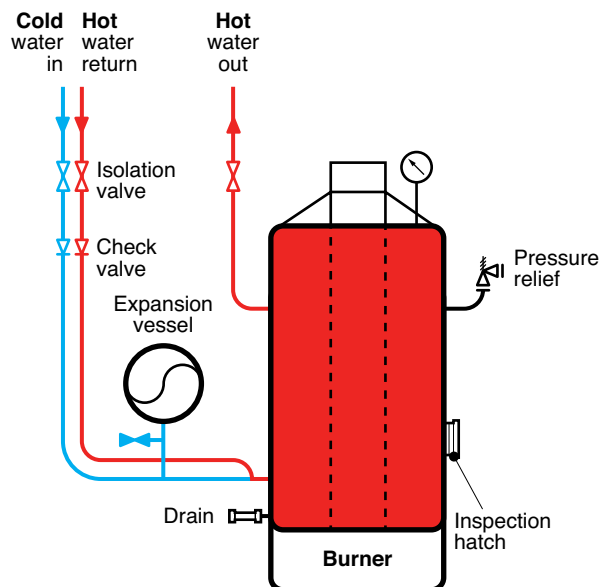

Figure 2.7 Direct-fired (gas) water heaters

Indirect heating calorifier vessel

2.25 In these vessels, the cold water typically enters at the base of the calorifier, creating an area below the coil where the initial blended water temperature may support microbial growth (Figure 2.8). Stratification, which may occur in large calorifiers, should be avoided and fitting a timer-controlled shunt pump to circulate the water from the top of the calorifier to the base during the period of least demand should be considered. The shunt pump should be activated when demand is at its lowest and the temperature within the calorifier is likely to be highest, this is often during the early hours of the morning. The boiler plant (or other calorifier heat source) should be heating while the shunt pump is active to ensure a temperature of at least 60 °C is achieved throughout the vessel for at least one continuous hour a day.

2.26 Ideally, the calorifier will have specific connections for the shunt pump return, as low down on the calorifier as possible. For existing calorifiers without suitable connections, the cold water feed may be used. Shunt pump operation should not be done or any alteration carried out before cleaning and descaling the calorifier, as operating the pump may disturb sludge or sediment. As an alternative to shunt pumps, some calorifiers are fitted with coils extending to the base to promote convective mixing during heating. Particulate matter can accumulate at the base of the calorifier so the design should incorporate an easily accessible drain valve.

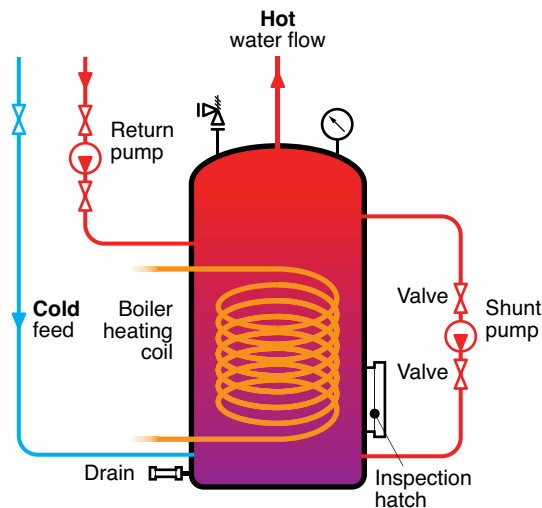

Figure 2.8 Indirect heating calorifier vessel

Calorifiers attached to solar heating systems

2.27 Hot water storage cylinders (calorifiers) attached to solar heating systems or other microgeneration systems (Figure 2.9) often have two heating coils one fed from the conventional heat source (boiler, heat exchanger etc) and one from the solar panels. The solar coil is usually positioned at the bottom of the cylinder and is used to pre-heat the 'dedicated solar volume' – the volume of water that can only be heated by the solar input. The boiler coil is fitted above the solar coil to raise the temperature of the water at the top of the vessel to 60 °C .

2.28 Calorifiers attached to solar heating systems should be managed, monitored and maintained to achieve the flow temperatures as for conventionally heated calorifiers throughout the year. As with conventional calorifiers, there will be temperature stratification providing favourable conditions for microbial growth including legionella at the base of the vessel. However, in times where there is little heat gain from the panels there may be a larger volume at a reduced temperature than in conventional systems. These systems should be designed so that the hot water temperature is not compromised during times when there is little heat gain from the solar panels. If the solar coil does not generate temperatures that bring about thermal inactivation of legionella bacteria; and the residence time for water in contact with the boiler coil at 60 °C is less than that required to effect thermal inactivation, a further level of control should be provided. For example, consideration should be given to programming the boiler coil to heat the entire contents of the solar hot water cylinder once daily, preferably during a period when there is little demand for hot water. A shunt pump may also be used to move hot water from the top of the calorifier to the base, however, it should not be used continuously except for about one hour daily and in all cases the pump should be controlled by a time clock. Where temperature control is not achieved, other measures such as using appropriate biocides should be considered.

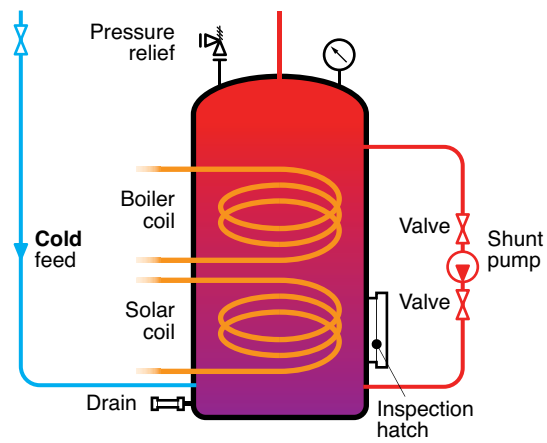

Figure 2.9 Solar-heated calorifiers

Water system design and commissioning

2.29 Plant or water systems should be designed and constructed to be safe and without risks to health when used at work. Such hazards may be of a physical, chemical or microbial nature such as the risks associated with colonisation and growth of legionella bacteria within the water system. The type of system installed depends on the size and configuration of the building and the needs of the occupants but the water systems should be designed, managed and maintained to comply with:

- the Construction (Design and Management) Regulations 2007 (CDM);¹⁸
- the Building Regulations 2010 (and associated amendments);¹⁹
- for systems provided with water from the public supply – for England and Wales, The Water Supply (Water Fittings) Regulations 1999 and for Scotland, the Scottish Water Byelaws 2004;
- for systems provided with water from private sources – The Private Water Supplies Regulations 2009;²⁰ The Private Water Supplies (Wales) Regulations 2010;²¹ or The Private Water Supplies (Scotland) Regulations 2006;²²
- BS EN 806 (Parts 1–5) *Specifications for installations inside buildings conveying water for human consumption*;²³
- BS 8558 *Guide to the design, installation, testing and maintenance of services supplying water for domestic use within buildings and their curtilages*;²⁴
- CIBSE Guide G *Public Health and Plumbing Engineering*.²⁵

2.30 Any subsequent changes within buildings may result in modifications to water systems that incorporate features from different design styles and materials. Any modifications should comply with the requirements and standards in paragraph 2.29 as if incorrectly designed, these can present a foreseeable risk of exposure to legionella.

Water system design considerations

2.31 The design of the water systems should identify and take into account the following factors:

- the source of the water must meet The Water Supply (Water Quality) Regulations 2000²⁶ or The Private Water Supplies Regulations 2009 and equivalent legislation for Wales and Scotland and must be wholesome at draw-off points;
- water components that may increase the risk of colonisation, eg blending valves, flexible hoses etc;
- the potential for stagnation leading to microbial growth where buildings are not to be fully occupied immediately or where systems are commissioned as occupation occurs, eg infrequently or intermittently used buildings.

2.32 A well-designed system should incorporate the following points:

- an adequate supply of hot and cold water available, particularly at periods of peak demand, while avoiding excessive storage. In buildings where stored water is not essential, consideration should be given to direct mains systems with local POU water heaters;

- all parts of the system including storage tanks, water heaters, pipework and components and associated equipment containing water are designed to avoid water stagnation by ensuring flow through all parts of the system. Low use outlets should be installed upstream of frequently used outlets to maintain frequent flow, eg an emergency shower installed upstream of a frequently used toilet. Consideration should be given to self-flushing fittings which are validated to show they are effective and do not introduce any additional risks;
- avoidance of temperatures in any water storage vessels, distributed water pipework and any associated equipment that support microbial growth, including legionella;
- single check valves are commonly used to prevent backflow of hot water to the cold feed. These valves should be rated for hot water use, as one side will be in contact with potentially hot water. Where applicable, an anti-gravity loop should be installed in the supply pipework as a failsafe mechanism should the single check valve fail;
- design measures to improve energy efficiency targets and reduce water usage should be assessed at the design stage to ensure the control of legionella is not compromised.

2.33 Materials used in building water systems must be compatible with the physical and chemical characteristics of water supplied to the building to reduce corrosion or prevent excessive scale formation of system pipework and components. Domestic water systems must not use materials that support microbial growth, such as those containing natural rubber, hemp, linseed oil-based jointing compounds and fibre washers. Similarly, any synthetic materials used should not adversely affect water quality by supporting microbial growth. Water fittings and components should be used that comply with the Water Regulations Advisory Scheme (WRAS) approval scheme²⁷ which lists products that have been tested and comply with BS 6920.

2.34 It is important that there should be ease of access to all parts of the system, components and associated equipment for management and maintenance purposes, eg tanks, calorifiers, thermostatic mixing valves (TMVs), blending valves, circulation pumps etc. Isolation valves should be included in all locations to facilitate maintenance and the implementation of control measures. The pipework and any components should be easy to inspect so that the thermal insulation and temperature monitoring can be checked.

2.35 In buildings where there are those with an increased susceptibility to infection or with processes requiring specific water characteristics, materials of an enhanced quality may be required. Healthcare buildings and care homes should specifically take note of alerts and advice from the Department of Health and Health Facilities Scotland. For example, healthcare premises are advised against the use of ethylene propylene diene monomer (EPDM) lined flexible hoses (tails) as these have been shown to be a risk of microbial colonisation. Such flexible connections should therefore only be used in healthcare premises where an installation has to move during operation or is subject to vibration.

Cold water systems

2.36 The general principles of design should be aimed at avoiding temperatures within the system that encourage the growth of microorganisms including legionella with the following taken into account:

- Cold water storage tanks should be installed in compliance with The Water Supply (Water Fittings) Regulations 1999 and Scottish Water Byelaws 2004. To prevent dirt and other potential nutrients getting in, they should have

secure, tightly fitting lids (Figure 2.10). Insect and vermin screens should be fitted to protect any pipework open to the atmosphere, such as the overflow pipe and vent. Where screens are fitted, they should be installed so they do not hold water. To avoid stagnation, where multiple cold water storage tanks are fitted, they should be connected to ensure each tank fills uniformly and water is drawn off through each of the tanks. Access ports should be provided on cold water tanks for inlet valve maintenance, inspection and cleaning.

- All pipe branches to individual outlets should be capable of delivering cold water at a temperature that is as close to the incoming water temperature within two minutes of running.
- The volume of stored cold water should be minimised and should not normally exceed that required for one day's water use although in healthcare premises, a nominal 12 hours total onsite storage capacity is recommended.
- There should be a regular water flow throughout the system and all outlets to avoid stagnation. In cold water storage tanks this can be facilitated by locating inlet and outlet pipes on opposing sides of the tank at different heights (see Figure 2.10).
- Thermal gain should be kept to a minimum by adequate lagging and separation of cold water services pipework and components from hot water services and heating systems; ensuring higher use outlets are installed at the end of each branch to improve flow; and considering, where appropriate, ventilation of void spaces and risers.
- Systems that encourage the movement of cold water in areas of the distribution system that are prone to stagnation and heat gain should be considered.
- All pipework and components carrying fluids other than water supplied by the water supplier and components should be clearly labelled.
- System components and associated equipment which require maintenance are easily accessible.
- Water fittings should only be chosen where they are compliant with The Water Supply (Water Fittings) Regulations 1999 and Scottish Water Byelaws 2004. In the case of non-metallic materials, this will also include conformity with BS 6920. The best method to ensure compliance is to select products from the Water Regulations Advisory Scheme Water Fittings and Materials Directory.

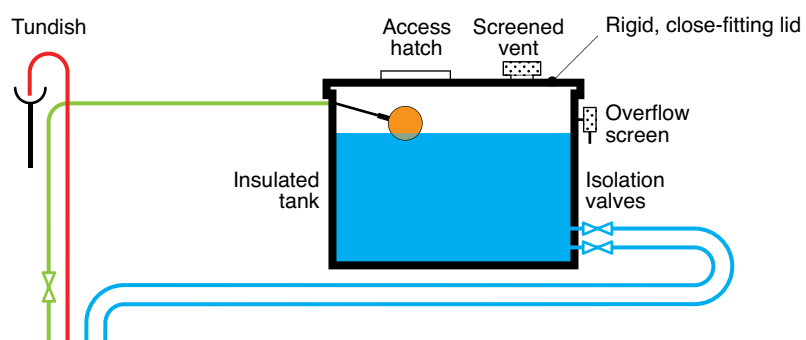

Figure 2.10 Acceptable tank design

Hot water systems

2.37 The general principles of design aim to avoid temperatures within the system that encourage the growth of legionella. Consideration should be given to the following:

- maintaining a supply temperature of at least 60 °C from the heat source and/or storage vessel (calorifier);

- the hot water circulating loop should be designed to give a return temperature to the calorifier from each loop of at least 50 °C (55 °C in healthcare premises);
- appropriate means for measuring temperature, eg thermometer/immersion pockets fitted on the flow and return to the calorifier and in the base of the calorifier;
- all pipe branches to individual outlets should be insulated and sufficiently short to enable the hot water at each outlet to reach 50 °C (55 °C in healthcare premises) within one minute of turning on the tap;
- the storage capacity and recovery rate of the calorifier should be selected to meet the normal daily fluctuations in hot water use without any significant drop in target supply temperature. The open vent pipe from the calorifier should be sufficiently raised above the water level and suitably sited in the water circuit to prevent hot water from being discharged in normal circumstances. The open vent should ideally discharge to atmosphere via a tundish providing a safe and visible warning of a fault condition;
- where more than one calorifier is used, they should be connected in parallel and deliver water at a temperature of at least 60 °C;
- to overcome localised failures in the distribution system, circulating pump design and the correct commissioning of balancing valves are key issues to ensure flow throughout all parts of the hot water system, particularly the hot water return legs. Balancing the hot water system flow and return circuits is critical to avoid long lengths of stagnant pipework that is likely to be at a lower temperature (see Figure 2.11);
- the calorifier drain valve should be located in an accessible position at the lowest point and as close as possible to the vessel, so that accumulated particulate matter can be safely drained;
- all types of water heaters, including storage calorifiers, should be designed and installed so that they are safe to use and maintain, and able to be inspected internally, where possible.

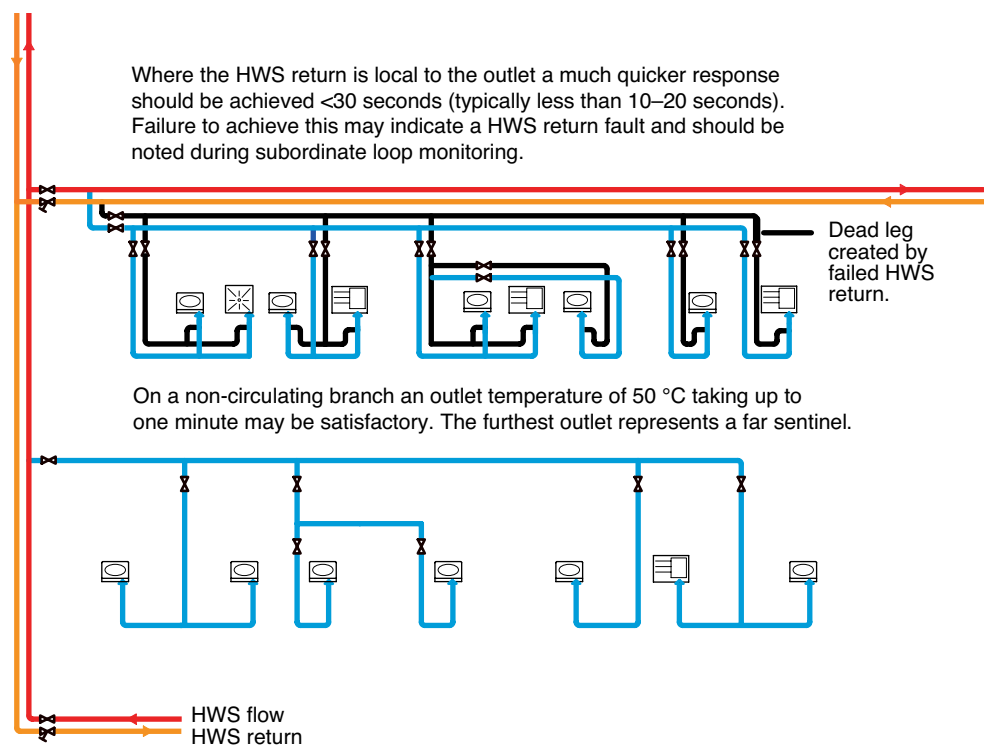

Figure 2.11 Hot water flow and return system showing a failure in the hot water system return

Expansion vessels

2.38 Expansion vessels in systems operating at steady temperature and pressure may have long periods without exchanging any significant amount of water and therefore can be at risk of aiding microbial growth.

2.39 To minimise the risk of microbial growth, expansion vessels should be installed:

- in cool areas on cold flowing pipes;
- mounted as close to the incoming water supply as possible;
- mounted vertically on pipework to minimise any trapping of debris;
- with an isolation and drain valve to aid flushing and sampling;
- to minimise the volume retained within them;
- designed to stimulate flow within the vessel.

Info box 2.1: Hydraulic accumulators

Where water is boosted via pumps, hydraulic accumulators (pressurised vessels that buffer variations in pressure so acting like a shock absorber) are often used to reduce pressure surges from the pumps and may reduce the demand frequency. When correctly installed, hydraulic accumulators will partially fill and empty between each pump run and should exchange water at regular intervals, which will reduce the risk of stagnation.

In pressurised systems, a means of accommodating water expansion (caused by the water heating) is required. This is often achieved with the use of an expansion vessel. However, these may not fill and empty where the system pressure and temperature remains steady.

There are several types of vessel available including diaphragm or bladder type, with fixed and interchangeable (replaceable) bladders, as shown below. These internal bladders are often made of synthetic rubber such as EPDM and may support the growth of microorganisms including legionella, so check to see if these are approved against BS 6920. Vessels with a 'flow through' design should provide less opportunity for water to stagnate and become contaminated (as in the latter design).

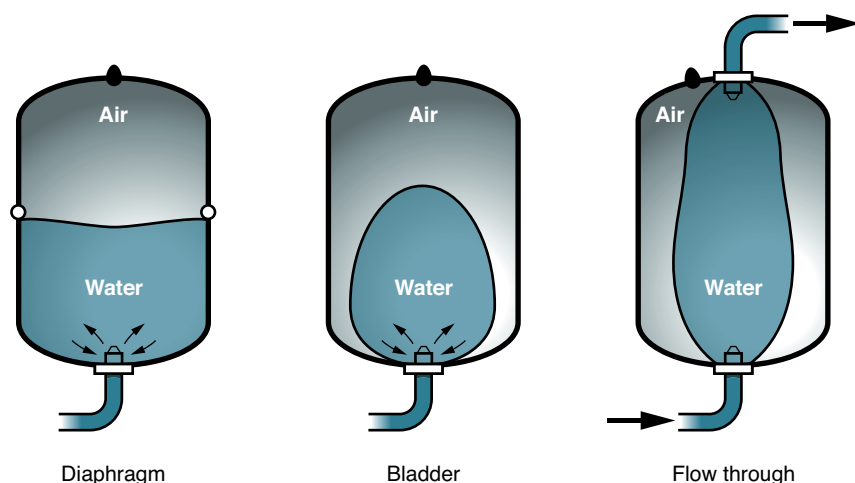

Expansion vessels

Commissioning

2.40 Commissioning of a water system means the bringing of a new system into operation and applies to all component parts of a building water system including attached equipment. The aim of such commissioning is to check the system is performing to design specifications, that there are no leaks and that the flow of the hot water system is balanced. From a microbiological perspective, the period between filling the system and bringing it into normal use is potentially the most hazardous. A risk assessment should be performed before commissioning, to identify and take into account the potential for stagnation as this may lead to microbial growth where buildings are not to be fully occupied immediately or where systems are commissioned as occupation occurs, eg infrequently or intermittently used buildings.

2.41 Any new water system will require, as a minimum, flushing and disinfection before being brought into use, and larger more complex systems may also require disinfection. The building commissioning process should take into account the size and complexity of the water system. A new, correctly designed and installed water system should provide wholesome water at every outlet and where there are any problems, the design or installation defect should be identified and rectified.

2.42 Before commissioning, the nature of the incoming water supply must be determined. If it is a public water supply, the water supplier will be able to provide details of the testing carried out in the local water supply zone in which the building is situated. If there is any doubt about the condition of the underground supply pipe connecting the building to the public supply main, the water supplier should be contacted so that they can carry out an appropriate investigation and advise if any action is required by either them, or the premises owner. If the building has a private water supply, the local authority should be contacted to carry out a private water supply risk assessment, if this has not been done already. The building owner is responsible for complying with the regulatory requirements as notified by the water supplier or the local authority, as appropriate, irrespective of whether it is a public or private water supply, or a combination of both.

Small developments

2.43 Small developments (eg individual commercial or light industrial units, small offices, rented domestic houses) where water systems are simple, should be thoroughly flushed before use, but this should be done as close to occupation as possible to minimise the possibility of microbial growth.

Large developments

2.44 Before use, all water systems should be cleaned, flushed and disinfected as specified in BS EN 806 and BS 8558. This involves adding an effective disinfectant, such as chlorine or chlorine dioxide, drawing it throughout the system and leaving it for a specified time (the contact time) to take effect. It is important to monitor the levels of residual chlorine at selected outlets to ensure the minimum required concentration is maintained throughout the contact period. Where chlorine is used as the biocide, the pH of the water should be checked as the efficacy of chlorine can be adversely affected at pH values over 7.6.

2.45 If water turnover is anticipated to be low initially, it may be advisable not to commission certain parts of the system, such as cold water storage tanks, until the building is ready for occupation. This will ensure flushing during low use periods will draw directly on the mains supply rather than intermediate storage. The manufacturer of any component to be bypassed should be consulted for any requirements, such as whether it needs to be filled or can remain empty until it is brought into use.

2.46 In most cases, water systems will need to be pressure tested with water but once filled, wetted systems should not be drained down as this may not be fully effective and biofilm can develop in areas where there are residual pockets of water or high humidity. Alternatively, compressed air or an inert gas may be used, by trained and competent personnel, to pressure test water systems for leaks.

2.47 If there is a prolonged period between pressure testing using water and full occupation of the development, a procedure should be adopted to maintain water quality in the system. Weekly flushing should be implemented to reduce stagnation and the potential for microbial growth, keep temperatures below 20 °C and to ensure residual chemical treatment levels eg the low level of chlorine in the incoming water supply, is maintained throughout the system.

2.48 In large systems where a long period of time from filling to occupation cannot be avoided, continuous dosing with an appropriate concentration of biocide as soon as the system is wetted combined with regular flushing at all outlets can control the accumulation of biofilm more effectively than flushing and temperature control alone. While other disinfection methods could be used, maintaining 1–3 mg/l of chlorine dioxide is generally effective, however dosing at such high levels may reduce the life of the system pipework and components. This initial high-level disinfection should not be confused with ongoing dosing at lower levels in operational systems where the water is intended for human consumption. National conditions of use require that the combined concentration of chlorine dioxide, chlorite and chlorate in the water entering supply do not exceed 0.5 mg/l as chlorine dioxide.

2.49 Where biocide dosing is used, a regime of flushing and monitoring is required to ensure the disinfectant reaches all parts of the system and is maintained at an adequate concentration level, which should be recorded.

Buildings temporarily taken out of use (mothballing)

2.50 Where a building, part of a building or a water system is taken out of use (sometimes referred to as mothballing), it should be managed so that microbial growth, including legionella in the water, is appropriately controlled.

2.51 All mothballing procedures are a compromise between adequate control of microbial growth, the use of water for flushing (while avoiding waste) and degradation of the system by any disinfectant added. Where disinfectants are used, these should leave the system fit for its intended purpose.

2.52 In general, systems are normally left filled with water for mothballing and not drained down as moisture will remain within the system enabling biofilm to develop where there are pockets of water or high humidity. The water in the system also helps to avoid other problems associated with systems drying out, including failure of tank joints and corrosion in metal pipework. The systems should be recommissioned as though they were new (ie thoroughly flushed, cleaned and disinfected) before returned to use.

Operation and inspection of hot and cold water systems

2.53 The risks from legionella should be identified and managed and paragraphs 2.53-2.79 give guidance on the operation and maintenance of hot and cold water systems. Building water systems should be routinely checked where there is a risk from legionella to ensure that:

- there is a good turnover of water;
- adequate control parameters at outlets are achieved, ie temperature and/or biocide levels, and inspected for cleanliness.

Arrangements should be in place for the key control parameters to be monitored by those with the appropriate training and expertise. Alternatively, building management systems are increasingly used to provide an automated monitoring programme, allowing for early detection of failures in maintaining the control regime.

2.54 All inspections and measurements should be recorded with the following details:

- the name of the person undertaking the survey, verified or authenticated by a signature or other appropriate means, such as electronic verification;
- the date on which it was made;
- sufficient details of the sample location so that a repeat sample can be taken at the same location, if necessary.

Supply water

2.55 The water supply to the building will be from either a public or private supply, or a combination of both. In either case, it is a requirement that the supply is wholesome and suitable for all domestic purposes as set out in the Water Industry Act 1991²⁷ or in Scotland, the Water (Scotland) Act 1980.²⁸







2.56 The temperature of the incoming water will depend on whether the supply originates from ground or surface water sources. The temperature of ground water in the UK is typically around 12 °C, whereas surface water temperatures can vary from 4 °C in a cold winter to 23 °C during a very hot summer. Accordingly, incoming water temperature should be well below 20 °C for most, if not all of the year. In an exceptionally hot summer, it may be necessary to review the risk assessment and take appropriate action to mitigate the risk to ensure regular water flow through tanks.

Cold water systems

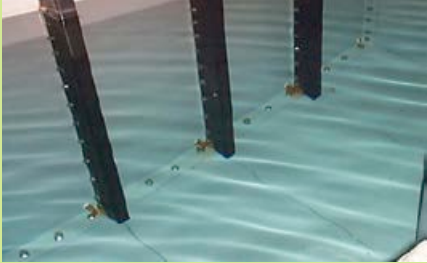
2.57 An annual inspection of the cold water storage tank should be done to check its condition inside and outside, and the water within it. Figure 2.12 demonstrates the condition of cold water storage tanks and when action should be taken. The lid should be closely fitted and in good condition. The insect and vermin screen on the overflow and warning pipes and any vents should be intact and in good condition. The thermal insulation should be in good condition so that it protects from extremes of temperature. The water surface should be clean and free from any visible, significant contamination. The cold water storage tank should be cleaned,

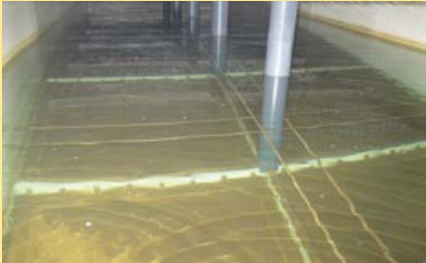
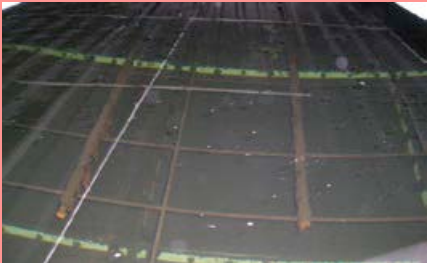
disinfected and any faults rectified. If debris or traces of vermin are found, the inspection should be carried out more frequently.

Figure 2.12 Cold water storage tank inspection

| | |
|--|--|
|  |  |
| Clean tank but with slight corrosion on bolts | Light debris but corrosion to restraining bars |
|  |  |
| Moderate fouling suggesting cleaning should be conducted during the next 12 months | Slight to moderate level of debris, tank cleaning should be planned. Hollow tube supports should also no longer be used – see EFA/2013/004 at www.dhsspsni.gov.uk/efa-2013-004.pdf |
|  |  |
| Heavy debris and corrosion of internal parts that will require remedial works | Severe stagnation could indicate that the tank is oversized, or not being used |
|  |  |
| Unusually heavy scale formation requiring more than a regular clean and disinfection | Gel coat (glass reinforced plastic) failure resulting in local biological fouling (dark spots) |

2.58 Whenever the building use pattern changes, a record of the total cold water consumption over a typical day should be established to confirm that there is reasonable flow through the tank and that water is not stagnating.

2.59 Monitoring for temperature or any disinfectant concentration in cold water should be carried out at sentinel draw-off points, selected to represent the overall building water system. In a simple cold water system, the sentinel points are typically the furthest tap (far sentinel) and the nearest (near sentinel) to the supply or storage tank. In deciding which outlets to identify as sentinels, the layout of the distribution system should be considered rather than the location of the outlet. More complex systems are likely to have several far sentinels, such as the extremity of each of several risers or down services. Any parts of the system not represented by far and near sentinels should be identified and additional outlets selected for monitoring that represent the excluded section.

2.60 Maintaining regular movement of cold water in sections prone to stagnation and guarding against excessive heat gain by using insulation on the cold water tanks and pipework is the most effective legionella control measure in CWDS. For most buildings, carrying out these measures is all that is required.

Hot water systems

2.61 Where standby units are provided, procedures should be in place to allow these units to be incorporated into routine use safely. Standby pumps should be used at least once each week to avoid water stagnation, and standby calorifiers need a suitable procedure to ensure the risk is controlled before they are brought back into service.

Non-circulating HWS

2.62 Monitoring temperature or any other control measure in hot water should be conducted at sentinel points, specifically selected to represent the condition of water in the system. In a non-circulating (single pipe) HWS, the sentinel points would typically be the taps furthest (far sentinel) and the nearest (near sentinel) to the hot water heater (calorifier). In branched systems, the outlets at the ends of significant spurs should be identified as additional far sentinel points. In either case, the layout of the distribution system should be considered rather than the location of the outlet, as they might not correspond.

Circulating HWS principal loops

2.63 In circulating systems the far sentinels are the return legs at a point towards the end of the recirculating loop. Where the system consists of several recirculating loops (demonstrated in Appendix 2.4), the end of each should be identified as far sentinel points for monthly monitoring. In either case, the layout of the distribution system should be considered rather than the location of the outlets, as they might not correspond.

Subordinate and tertiary HWS loops

2.64 Many larger circulating HWS have additional loops consisting of a smaller bore pipe branching from the flow leg of a principal loop to supply a group of outlets and connecting back to the return leg. In systems such as this, the smaller bore loops are the subordinate loops and the larger loops are the principal loops. Subordinate loops should be monitored ideally at a suitable return leg or from a representative outlet, in order to test all subordinate loops quarterly. However, large and complex HWS, eg in hospitals, often have localised loops that feed only one or two outlets and these can be identified as tertiary loops (demonstrated in Appendix 2.5).

Temperature profiling (representative outlet temperature monitoring)

2.65 Temperature profiling is a useful tool to verify a water distribution system is maintaining temperatures in all parts of the system in normal use, to control adequately any microbial growth, including legionellae. Rationalising the choice of where to monitor complex systems requires considering the layout to identify the principal loops. These are typically relatively few in number and will take hot water to and from parts of the building, eg toilets or other facilities, and will be one above another in a multi-storey building supplied by a vertical flow and return loop (often in a service void known as a riser and sometimes with access doors on each storey). In lower rise large buildings, the principal loops could run horizontally, typically above false ceilings in corridors.

2.66 As it may be impractical to monitor every part of a complex system, some form of rationalisation and prioritisation should be applied. As with cold water systems, any parts of the system not represented by sentinels should be identified, and additional outlets selected for less frequent monitoring to create a temperature profile of the whole system over a defined time.

2.67 HWS which supply outlets to high-risk users and incorporate tertiary loops, eg showers in healthcare premises, should be identified as areas for additional temperature monitoring.

Low storage volume heaters

2.68 Low storage volume heaters (ie no greater than 15 litres) such as instantaneous units and POU heaters, may be generally regarded as lower risk.

Info box 2.2: Low-risk systems

An example of a low-risk situation:

- in a small building without people especially 'at risk' from legionella bacteria;
- where daily water usage is inevitable and sufficient to turn over the entire system;
- where cold water comes directly from a wholesome mains supply (no stored water tanks);
- where hot water is fed from instantaneous heaters or low storage volume water heaters (supplying outlets at 50 °C);
- where the only outlets are toilets and hand washbasins (no showers).

2.69 Low storage volume heaters serving hot water outlets should be able to achieve a peak temperature of 50–60 °C and where the thermostat is set at these temperatures for this purpose, staff and other users should be informed not to adjust the heater. A unit which is not capable of achieving this, eg a preset thermostat, should only be used where there is a very high turnover or an alternative control measure is in place.

2.70 Low storage volume heaters, which includes electric showers, often have spray nozzle outlets and these should be inspected, cleaned and descaled as part of the showerhead and hose cleaning regime.

2.71 If these units are not regularly used or set to supply warm water, the risk from legionella is likely to increase dramatically and may increase further, where the units are supplied from a cold water storage tank. The risk assessment should take into account the usage of the units, the susceptibility of those using the units and include a suitable monitoring regime where the risk is considered significant.

Maintenance

Water softening

2.72 Light scale formation on the inner surfaces of pipes can be protective against the leaching of metals such as lead or copper, but heavier deposits are likely in hard water areas. These deposits increase the surface area and therefore the potential for microbial colonisation (biofilm formation) and can provide protection from the effects of biocides. In hard water areas, softening of the cold water supply to the hot water distribution system should be considered. This is to reduce the risk of scale being deposited at the base of the calorifier and heating coils, especially at temperatures greater than 60 °C, and the potential for scale build-up within the system pipework and components (eg TMVs) which may significantly reduce flow and adversely affect the efficiency of the system.

2.73 System materials need to be of a type that are resistant to corrosion (eg copper, stainless steel) as very soft water, natural or artificially softened, may lead to increased corrosion of the system pipework and materials. Where water softening systems are used, these should be fitted before any biocide treatment application. Suitable sample points should be fitted before and after the softener to allow for the operational testing of hardness and microbiological sampling if contamination is suspected.

Thermostatic mixing valves

2.74 TMVs are valves that use a temperature sensitive element and blend hot and cold water to produce water at a temperature that safeguards against the risk of scalding, typically between 38 °C and 46 °C depending on outlet use. The blended water downstream of TMVs may provide an environment in which legionella can multiply, thus increasing the risks of exposure.

2.75 The use and fitting of TMVs should be informed by a comparative assessment of scalding risk versus the risk of infection from legionella. Where a risk assessment identifies the risk of scalding is insignificant, TMVs are not required. The most serious risk of scalding is where there is whole body immersion, such as with baths and showers, particularly for the very young and elderly, and TMVs should be fitted at these outlets. Where a risk assessment identifies a significant scalding risk is present, eg where there are very young, very elderly, infirm or significantly mentally or physically disabled people or those with sensory loss, fitting TMVs at appropriate outlets, such as hand washbasins and sinks, is required.

2.76 Where TMVs are fitted, consider the following factors:

- where practicable, TMVs should be incorporated directly in the tap fitting, and mixing at the point of outlet is preferable;
- where TMVs are fitted with low flow rate spray taps on hand washbasins, the risk is increased;
- TMV valves should be as close to the POU as possible to minimise the storage of blended water;
- where a single TMV serves multiple tap outlets, the risk can be increased;
- where TMVs are designed to supply both cold and blended water, an additional separate cold tap is rarely needed and may become a low use outlet.

Info box 2.3: Thermostatic mixing valves

Where a scalding risk is assessed as low (eg where healthy users immerse their whole body), type 2 TMVs that can be overridden by the users are required by building regulations. Where a scalding risk is considered significant (eg where users are very young, very elderly, infirm or significantly mentally or physically disabled or those with sensory loss) then type 3 TMVs that are pre-set and fail-safe should be provided (but are required at healthcare premises) and should be checked regularly to ensure they are fail-safe if the cold water supply pressure is interrupted.

Regular flushing of showers and taps

2.77 Consideration should be given to removing infrequently used showers and taps and where removed, the redundant supply pipework should be cut back, as close as possible, to a common supply, eg to the recirculating pipework or the pipework supplying a more frequently used upstream fitting.

2.78 The risk from legionella growing in peripheral parts of the domestic water system, such as dead legs off the recirculating hot water system, may be minimised by regular use of these outlets. When outlets are not in regular use, weekly flushing of these devices for several minutes can significantly reduce the risk of legionella proliferation in the system. Once started, this procedure has to be sustained and logged, as lapses can result in a critical increase in legionella at the outlet. Where there are high-risk populations, eg healthcare and care homes, more frequent flushing may be required as indicated by the risk assessment.

Checklist for hot and cold water systems

2.79 The frequency of inspecting and monitoring the hot and cold water systems will depend on their complexity and the susceptibility of those likely to use the water. The risk assessment should define the frequency of inspection and monitoring depending on the type of use and user and particularly where there are adjustments made by the assessor to take account of local needs. Table 2.1 provides a checklist for hot and cold water systems with an indication of the frequency of inspection and monitoring.

Table 2.1: Checklist for hot and cold water systems

| Service | Action to take | Frequency |
|--|---|---|
| Calorifiers | Inspect calorifier internally by removing the inspection hatch or using a boroscope and clean by draining the vessel. The frequency of inspection and cleaning should be subject to the findings and increased or decreased based on conditions recorded | Annually, or as indicated by the rate of fouling |
| | Where there is no inspection hatch, purge any debris in the base of the calorifier to a suitable drain Collect the initial flush from the base of hot water heaters to inspect clarity, quantity of debris, and temperature | Annually, but may be increased as indicated by the risk assessment or result of inspection findings |
| | Check calorifier flow temperatures (thermostat settings should modulate as close to 60 °C as practicable without going below 60 °C) Check calorifier return temperatures (not below 50 °C). | Monthly |
| Hot water services | For non-circulating systems: take temperatures at sentinel points (nearest outlet, furthest outlet and long branches to outlets) to confirm they are at a minimum of 50 °C within one minute (55 °C in healthcare premises) | Monthly |
| | For circulating systems: take temperatures at return legs of principal loops (sentinel points) to confirm they are at a minimum of 50 °C (55 °C in healthcare premises). Temperature measurements may be taken on the surface of metallic pipework | Monthly |
| | For circulating systems: take temperatures at return legs of subordinate loops, temperature measurements can be taken on the surface of pipes, but where this is not practicable, the temperature of water from the last outlet on each loop may be measured and this should be greater than 50 °C within one minute of running (55 °C in healthcare premises). If the temperature rise is slow, it should be confirmed that the outlet is on a long leg and not that the flow and return has failed in that local area | Quarterly (ideally on a rolling monthly rota) |
| | All HWS systems: take temperatures at a representative selection of other points (intermediate outlets of single pipe systems and tertiary loops in circulating systems) to confirm they are at a minimum of 50 °C (55 °C in healthcare premises) to create a temperature profile of the whole system over a defined time period | Representative selection of other sentinel outlets considered on a rotational basis to ensure the whole system is reaching satisfactory temperatures for legionella control |
| POU water heaters (no greater than 15 litres) | Check water temperatures to confirm the heater operates at 50–60 °C (55 °C in healthcare premises) or check the installation has a high turnover | Monthly–six monthly, or as indicated by the risk assessment |

| | | |
|----------------------------------|---|---|
| Combination water heaters | Inspect the integral cold water header tanks as part of the cold water storage tank inspection regime, clean and disinfect as necessary. If evidence shows that the unit regularly overflows hot water into the integral cold water header tank, instigate a temperature monitoring regime to determine the frequency and take precautionary measures as determined by the findings of this monitoring regime | Annually |
| | Check water temperatures at an outlet to confirm the heater operates at 50–60 °C | Monthly |
| Cold water tanks | Inspect cold water storage tanks and carry out remedial work where necessary | Annually |
| | Check the tank water temperature remote from the ball valve and the incoming mains temperature. Record the maximum temperatures of the stored and supply water recorded by fixed maximum/minimum thermometers where fitted | Annually (Summer) or as indicated by the temperature profiling |
| Cold water services | Check temperatures at sentinel taps (typically those nearest to and furthest from the cold tank, but may also include other key locations on long branches to zones or floor levels). These outlets should be below 20 °C within two minutes of running the cold tap. To identify any local heat gain, which might not be apparent after one minute, observe the thermometer reading during flushing | Monthly |
| | Take temperatures at a representative selection of other points to confirm they are below 20 °C to create a temperature profile of the whole system over a defined time period. Peak temperatures or any temperatures that are slow to fall should be an indicator of a localised problem | Representative selection of other sentinel outlets considered on a rotational basis to ensure the whole system is reaching satisfactory temperatures for legionella control |
| | Check thermal insulation to ensure it is intact and consider weatherproofing where components are exposed to the outdoor environment | Annually |
| Showers and spray taps | Dismantle, clean and descale removable parts, heads, inserts and hoses where fitted | Quarterly or as indicated by the rate of fouling or other risk factors, eg areas with high risk patients |
| POU filters | Record the service start date and lifespan or end date and replace filters as recommended by the manufacturer (0.2 µm membrane POU filters should be used primarily as a temporary control measure while a permanent safe engineering solution is developed, although long-term use of such filters may be needed in some healthcare situations) | According to manufacturer's guidelines |
| Base exchange softeners | Visually check the salt levels and top up salt, if required. Undertake a hardness check to confirm operation of the softener | Weekly, but depends on the size of the vessel and the rate of salt consumption |
| | Service and disinfect | Annually, or according to manufacturer's guidelines |

| | | |
|----------------------------------|--|---|
| Multiple use filters | Backwash and regenerate as specified by the manufacturer | According to manufacturer's guidelines |
| Infrequently used outlets | <p>Consideration should be given to removing infrequently used showers, taps and any associated equipment that uses water. If removed, any redundant supply pipework should be cut back as far as possible to a common supply (eg to the recirculating pipework or the pipework supplying a more frequently used upstream fitting) but preferably by removing the feeding 'T'</p> <p>Infrequently used equipment within a water system (ie not used for a period equal to or greater than seven days) should be included on the flushing regime</p> <p>Flush the outlets until the temperature at the outlet stabilises and is comparable to supply water and purge to drain</p> <p>Regularly use the outlets to minimise the risk from microbial growth in the peripheral parts of the water system, sustain and log this procedure once started</p> <p>For high risk populations, eg healthcare and care homes, more frequent flushing may be required as indicated by the risk assessment</p> | Weekly, or as indicated by the risk assessment |
| TMVs | <p>Risk assess whether the TMV fitting is required, and if not, remove</p> <p>Where needed, inspect, clean, descale and disinfect any strainers or filters associated with TMVs</p> <p>To maintain protection against scald risk, TMVs require regular routine maintenance carried out by competent persons in accordance with the manufacturer's instructions. There is further information in paragraphs 2.152– 2.168</p> | Annually or on a frequency defined by the risk assessment, taking account of any manufacturer's recommendations |
| Expansion vessels | <p>Where practical, flush through and purge to drain.</p> <p>Bladders should be changed according to the manufacturer's guidelines or as indicated by the risk assessment</p> | Monthly–six monthly, as indicated by the risk assessment |

Water treatment and control programmes for hot and cold water systems

2.80 Dutyholders are required to prevent or control the risk from exposure to legionella. Precautions include physical methods such as regular movement of hot and cold water in distribution pipework, regular flushing of outlets to ensure water cannot stagnate in the hot and cold water systems and POU filters. For control measures to be effective, it is essential to keep the whole system clean, as biofilms or inorganic matter such as scale can reduce the efficacy of any type of control measure significantly.

2.81 Although temperature is the traditional and most common approach to control, sometimes there can be technical difficulties in maintaining the required temperatures, particularly in older buildings with complex water systems. Control methods including water treatment techniques, when used correctly and if properly managed, can be effective in the control of legionella in hot and cold water systems. However, the selection of a suitable system for the control of legionella is complex and depends on a number of parameters, including system design, age, size, and water chemistry, all of which can contribute to the complexity and difficulty of achieving adequate control. There is no single water treatment control regime that is effective in every case, and each control method has both benefits and limitations.

Temperature regime

2.82 Where temperature is used, hot water should be stored at a minimum of 60 °C and distributed so it reaches a minimum temperature of 50 °C (55 °C in healthcare premises) within one minute at outlets. Where circulation is not possible, trace heating is sometimes used to maintain the water temperature in the spur so that it delivers at 50 °C within one minute of running, but only provided it is shown to be effective.

2.83 Much higher temperatures should be avoided because of the risk of scalding. At 50 °C, the risk of scalding is small for most people but the risk increases rapidly with higher temperatures and for longer exposure times. However, the risk, particularly to young children, the elderly or disabled and to those with sensory loss will be greater. Where a significant scalding risk is identified, using TMVs on baths and showers should be considered to reduce temperature and should be placed as close to the POU as possible. To ensure the correct function of TMVs, there needs to be a minimum temperature differential between the hot and cold water supplies and the mixed water temperature. Users should refer to the manufacturer's operating instructions to ensure these devices are working safely and correctly.

2.84 When using temperature as a control regime, as well as routine monitoring and inspection, the checks in Table 2.1 should also be carried out and remedial action taken if necessary.

Biocide treatments

2.85 Where biocides are used to treat water systems, like the temperature regime they require meticulous control and monitoring programmes in place if they are to be equally

effective. However, in healthcare premises, careful consideration should be given to any equipment that is connected to the water system that may be affected by the application of a biocide, eg renal and haemodialysis units. Due to the extremely sensitive nature of renal water plants, for healthcare premises reference should be made to *Water systems: Health Technical Memorandum 04-01* Part B (for England and Wales), or to *Scottish Health Technical Memorandum 04-01* (for Scotland).

2.86 If hot water is not needed for other reasons, eg for kitchens or laundries, and there is no requirement to store hot water at 60 °C (or distribute at 50 °C), then hot water temperatures can be reduced. As reducing hot water temperatures will leave the system vulnerable if there are any lapses in the biocide control regime, the control system should be checked at least weekly to ensure it is operating effectively and continuing to control legionella.

2.87 Any reduction of hot water temperatures should be carried out in stages and temperatures only reduced when efficacy against legionella is confirmed, with monitoring for legionella and biocide levels in the water system carried out at each stage.

2.88 However, reducing calorifier temperatures to below 60 °C, and using a biocide as the primary control measure, is currently not permitted in healthcare premises where there are patients who are at an increased risk of contracting legionnaires' disease. Healthcare premises should refer to *Water systems: Health Technical Memorandum 04-01* Part B (for England and Wales), or to *Scottish Health Technical Memorandum 04-01* (for Scotland).

2.89 It is essential that these water treatment programmes are monitored to demonstrate that the programmes are working within the established guidelines and are effective in controlling legionella bacteria in water systems. The frequency of monitoring and test procedures will vary according to the method selected.

2.90 Biocides used to treat water systems where water is used for domestic purposes may be contrary to water legislation and may make the water unwholesome. These systems should be selected with care and must comply with the requirements of The Water Supply (Water Quality) Regulations 2000, for Wales, the Water Supply (Water Quality) (Wales) Regulations 2010²⁹ and for Scotland, The Water Supply (Water Quality) (Scotland) Regulations 2001³⁰ and 2010.³¹ Additionally, the installation of any biocidal system must comply with the requirements of The Water Supply (Water Fittings) Regulations 1999 and for Scotland, the Scottish Water Byelaws 2004.

Chlorine dioxide

2.91 Chlorine dioxide is an oxidising biocide/disinfectant that when used correctly, has been shown to be effective at controlling both legionella and biofilm growth in hot and cold water systems. In the appropriate application, it may be used to aid legionella control where maintaining a conventional temperature regime is difficult or where the removal of all dead legs and little used outlets is impractical. Chlorine dioxide is usually produced on site from a chlorite-based precursor using a chlorine dioxide generator or dosing system by reaction with one or more other chemical precursors or by a catalytic oxidation process.

2.92 Use of chlorine dioxide as a legionella control strategy is subject to BS EN 12671³² and national conditions of use require that the combined concentration of chlorine dioxide, chlorite and chlorate in the drinking water does not exceed 0.5 mg/l as chlorine dioxide.

2.93 Establishing and maintaining a chlorine dioxide residual (as total oxidant) of 0.1– 0.5 mg/l at an outlet is usually sufficient to control legionella in the preceding

pipework, although in a heavily colonised system higher residuals may be necessary. The dosage rate of chlorine dioxide required to achieve this residual will be dependent on the length and complexity of the water distribution system, the water turnover rate and the extent to which the water system is contaminated with an established biofilm. In a relatively clean water system with a high water turnover, a dosage rate of up to 0.5 mg/l is usually sufficient to achieve the desired residual at the outlets. While chlorine dioxide is not affected by the pH or hardness of the water, it is sometimes difficult to monitor chlorine dioxide samples in domestic HWS due to its increased volatility causing the chlorine dioxide reserve to be lost when taking a water sample. In a system containing infrequently used outlets, a programme of regularly flushing the outlets should be maintained until a chlorine dioxide residual is detected.

2.94 Chlorine dioxide is a water soluble gas and can penetrate and control established biofilms. If a system is heavily colonised then it will have a significant chlorine dioxide demand and it may be some considerable time before a stable chlorine dioxide residual is established at the extremities of the system. During the clean-up phase, it may be necessary to maintain a higher dosage rate than 0.5 mg/l and outlets normally used for drinking purposes will require additional controls. In such cases, an offline super-disinfection with an elevated level of chlorine dioxide (20– 50 mg/l) may be necessary, but this should only be undertaken following a detailed risk assessment and the system should be flushed through thoroughly after cleaning.

2.95 Where some of the water is used for drinking purposes, but the desired microbial control cannot be achieved without the combined total oxidant levels at the outlets exceeding 0.5 mg/l then the relevant outlets should be clearly labelled as unsuitable for drinking. Alternatively, the oxidants can be removed from the water at the POU by means of a suitable activated carbon-based drinking water filter. However, where such outlets are in neonatal or augmented care units, these should be clearly labelled as unsuitable for ingestion, including making up neonates' feeds.

2.96 When introducing chlorine dioxide, the dosing system should typically be installed, for a combined hot and cold water system, on the inlet to the tank supplying water to the remainder of the system. For a hot water system, this would be on the cold water inlet to the calorifier. The dosage of chlorine dioxide should be proportional to the water flow and the dosing system should incorporate safeguards to prevent inadvertent overdosing. In the case of hot water distribution systems with calorifiers/water heaters operating conventionally (ie at 60 °C), there will be a tendency for chlorine dioxide to be lost by 'gassing off', especially if the retention time in a vented calorifier/water heater is long. In most cases, however, some level of total oxidant should be found in the hot water, although at concentrations far less than the 0.5 mg/l injected.

2.97 It may be difficult to establish the desired chlorine dioxide residual throughout all areas of a large complex water distribution system from a single dosing point, particularly if it is colonised by an established biofilm. Installing satellite-dosing systems may be needed to boost the residual at key areas, such as interposing tanks or upstream of calorifiers.

2.98 Excessive levels of chlorine dioxide should be avoided since they can encourage the corrosion of copper and steel pipework and high levels of chlorine dioxide can degrade certain types of polyethylene pipework particularly at elevated temperatures. Users of chlorine dioxide systems will need to consider these issues and when choosing a system these points should be checked to ensure that the supplier addresses them satisfactorily.

2.99 The chlorine dioxide dosing system should be inspected at least weekly to confirm that it is operating correctly and that there is no evidence of chemical

leakage. The treated water should be tested regularly at a suitable sample point downstream of the injection point to verify that there is at least 80% reaction efficiency, thus minimising the contribution of chlorite to the biocide dose; and at the sentinel outlets to verify the chlorine dioxide and total oxidant/chlorite residuals are as required. The dosing system should be serviced and maintained in accordance with the manufacturer's recommendations.

2.100 For most systems, the routine inspection and maintenance detailed in the bulleted list below is usually sufficient to ensure control, with any remedial action taken when necessary and recorded.

- weekly – check the system operation and chemical stocks in the reservoir;
- monthly – test the treated water for both chlorine dioxide and total oxidant/chlorite at an outlet close to the point of injection to verify the dosage rate and conversion yield;
- monthly – measure the concentration of chlorine dioxide at the sentinel taps – the concentration should be at least 0.1 mg/l; and adjust the chlorine dioxide dosage to establish the required residual at the sentinel sample points;
- annually – test the chlorine dioxide and total oxidant/chlorite concentration at a representative selection of outlets throughout the distribution system – the concentration should be at least 0.1 mg/l chlorine dioxide.

Copper and silver ionisation

2.101 Ionisation is the term given to the electrolytic generation of copper and silver ions providing a continuous release of ions in water. These are generated by passing a low electrical current between two copper and silver electrodes; copper and silver alloy electrodes may also be used. When used correctly, copper and silver ionisation is shown to be effective at controlling legionella and can penetrate and control established biofilms.

2.102 The Water Supply (Water Quality) Regulations 2001 set a standard for copper of 2 mg/l, which must not be exceeded. However, there is currently no standard for silver used for domestic purposes.

Info box 2.4: Guideline levels for silver

At the time of publication, the European Union and WHO do not dictate any established standards for silver, as there is currently insufficient data for recommending a concentration limit. Equipment manufacturers generally recommend copper (0.2–0.8 mg/l) and silver (0.02–0.08 mg/l) ion concentrations to control legionella effectively.

WHO states 'there is no adequate data with which to derive a health based guideline value for silver in drinking water'. WHO also states that 'special situations exist where silver may be used to maintain the bacteriological quality of drinking water and higher levels of up to 0.1 mg/litre could be tolerated in such cases without risk to health'.

2.103 Where some of the outlets on the treated water system are used for domestic purposes, rigorous controls and regular water testing needs to be maintained to ensure that the copper level does not exceed 2.0 mg/l as Cu^{2+} and the silver level does not exceed 0.1 mg/l as Ag^+ at these outlets.

2.104 Ionisation systems are typically fitted on the incoming mains supply before water storage treating both hot and cold water systems. These systems may also be installed in independent hot or cold water circuits as well as on a recirculating

pumped line treating a storage tank. If water softening systems are used, the ionisation system should be fitted after the softening system to avoid removal of some of the copper and silver ions by the water softening system resins. In hard water areas, a specific electrode evaluation and descaling procedure should be part of the programme as it is possible that the natural hardness will deposit on the electrodes and reduce ionisation efficiency.

2.105 Values of more than 0.2 mg/l copper and more than 0.02 mg/l silver are recommended at outlets to ensure effective control of legionella, and the ionisation system should be regularly checked to ensure it is capable of delivering enough copper and silver to maintain these concentration values at outlets while not exceeding the drinking water limits, if applicable.

2.106 Maintaining adequate silver ion concentrations in hard water systems can be difficult due to the build-up of scale on the silver electrodes potentially obstructing copper and silver ions release. Copper and silver ionisation systems that treat hard water systems should therefore be checked more regularly to ensure that the system is capable of delivering suitable ion levels throughout the system of more than 0.2 mg/l copper and more than 0.02 mg/l silver, measured at outlets. The ionisation process is pH sensitive and dosing levels may need increasing for pH levels greater than 7.6.

2.107 The copper and silver ionisation system should be regularly inspected and its electrodes cleaned as required to ensure that the system is delivering steady levels of more than 0.2 mg/l copper and more than 0.02 mg/l silver, measured at outlets, necessary to maintain control. Water samples should be taken regularly from the ionisation system and from the sentinel outlets and analysed by a UKAS-accredited laboratory to ensure enough copper and silver is produced by the system.

2.108 For most systems, routine inspection and maintenance is usually sufficient to ensure control and any remedial action should be taken when necessary and recorded:

- weekly – check rate and release of copper and silver ions in the water supply and install equipment capable of proportional dosing relative to flow;
- monthly – check copper and silver ion concentrations at sentinel outlets;
- annually – check the measurement of copper and silver ion concentrations at representative taps selected on a rotational basis once each year;
- check the condition and cleanliness of the electrodes and the pH of the water supply.

Chlorine

2.109 Chlorine is widely used to disinfect water supplies. Most mains water supplies will contain a low level chlorine residual in the range of 0.1–0.5 mg/l at the point where water enters a premises. This level of chlorine may not be sufficient to inhibit the growth of legionella within the water systems of a building and where necessary, supplementary dosing with the controlled addition of a further chlorine-based product may aid the control of legionella and biofilm.

2.110 Once diluted in the water supply the chlorine-based product dissociates to form hypochlorous acid and hypochlorite ions. The effectiveness of chlorine as a disinfectant is determined by the chlorine concentration, contact time, pH value, temperature, concentration of organic matter, and the number and types of microorganisms in the water.

2.111 WHO has set a health-based guideline maximum value of 5.0 mg/l for total chlorine as a residual disinfectant in drinking water. However, it is rarely used continuously in domestic water in buildings at levels higher than 1.0 mg/l as this would render the water unpalatable and may lead to an unacceptable level of corrosion.

2.112 While chlorine has an inhibitory effect on the formation of biofilm it is recognised as being less effective at penetrating and controlling established biofilms than some other oxidising disinfectants. Where a water system has an established legionella colonisation, the dosage of a chlorine product may suppress the growth of legionella.

2.113 Where a water system is relatively free from established biofilm, maintaining a free chlorine residual of 0.5–1.0 mg/l as Cl₂ at an outlet will help reduce the development of biofilm in the preceding pipework and aid the control of legionella. A programme of regularly flushing the outlets until free chlorine residual is maintained can significantly improve the effectiveness of control in pipework leading to little used outlets.

2.114 Where used, the chlorine product dosing system should be inspected at least weekly to confirm that it is operating correctly and that there is no evidence of chemical leakage. Safeguards should be in place to prevent any overdosing in the system.

2.115 For most systems, routine inspection and maintenance, as in the bullet list below, is usually sufficient to ensure control. Remedial action should be taken when necessary and recorded.

- weekly – check the system operation and chemical stocks in the reservoir;
- monthly – measure the concentration of free chlorine at the sentinel taps – the concentration should be 0.5–1.0 mg/l; and adjust the chlorine product dosage to establish the required residual at the sentinel sample points;
- annually – test the chlorine product concentration at a representative selection of outlets throughout the distribution system – the target concentration should be at least 0.5 mg/l free chlorine.

Silver stabilised hydrogen peroxide

2.116 Silver stabilised hydrogen peroxide has a history of use in the control of legionella in water systems. A silver hydrogen peroxide solution is injected directly into the water system and if applied and maintained according to the manufacturers' instructions, can be an effective means of control. As with any water treatment programme it should be validated to ensure it is effective in controlling legionella. The system should be flushed to remove any nutrients and disinfectant released by the process. Silver hydrogen peroxide should not be used in water systems supplying dialysis units.

Supplementary measures

Point of Use (POU) filters

2.117 POU filters prevent the discharge of planktonic legionella and other potentially pathogenic microorganisms (bacteria and parasites) from the tap and shower outlets. They should be used primarily as a temporary measure until a permanent safe engineering solution is developed, although long-term use of such filters may be needed in some healthcare situations. They may also be considered where high level of disinfection of water systems may dislodge biofilm. Where POU filters are fitted, they should be renewed and replaced according to the manufacturer's recommendations.

Ozone and UV treatment

2.118 The strategies previously described are dispersive, ie they are directly effective throughout the water system downstream from the point of application. A number of other strategies are available, eg UV irradiation or ozone, and these systems are only effective at or very close to the point of application. This usually results in the residual effect not being directly measurable in the circulating system. In large systems, it may be necessary to use a number of point applications of these treatments and the system suppliers will be able to advise appropriately.

Microbiological monitoring

2.119 Microbiological monitoring of domestic hot and cold water supplied from the mains is not usually required, unless the risk assessment or monitoring indicates there is a problem. The risk assessment should specifically consider systems supplied from sources other than the mains, such as private water supplies, and sampling and analysis may be appropriate.

Monitoring for legionella

2.120 Legionella monitoring should be carried out where there is doubt about the efficacy of the control regime or it is known that recommended temperatures, disinfectant concentrations or other precautions are not being consistently achieved throughout the system. The risk assessment should also consider where it might also be appropriate to monitor in some high risk situations, such as certain healthcare premises. The circumstances when monitoring for legionella would be appropriate include:

- water systems treated with biocides where water is stored or distribution temperatures are reduced. Initial testing should be carried out monthly to provide early warning of loss of control. The frequency of testing should be reviewed and continued until such a time as there is confidence in the effectiveness of the regime;
- water systems where the control levels of the treatment regime, eg temperature or disinfectant concentrations, are not being consistently achieved. In addition to a thorough review of the system and treatment regimes, frequent testing, eg weekly, should be carried out to provide early warning of loss of control. Once the system is brought back under control as demonstrated by monitoring, the frequency of testing should be reviewed;
- high-risk areas or where there is a population with increased susceptibility, eg in healthcare premises including care homes;
- water systems suspected or identified in a case or outbreak of legionellosis where it is probable the Incident Control Team will require samples to be taken for analysis (see Appendix 2.3).

2.121 Where monitoring for legionella is considered appropriate in hot and cold water systems, sampling should be carried out in accordance with BS 7592 *Sampling for Legionella organisms in water and related materials*.³³ The complexity of the system will need to be taken into account to determine the appropriate number of samples to take. To ensure the sample is representative of the water flowing around the system and not just of the area downstream of the fitting, samples should be taken from separate hot and cold outlets rather than through mixer taps or outlets downstream of TMVs or showers. Samples should be clearly labelled with their source location and if collected pre- or post-flushing.

2.122 In both hot and cold water systems, samples should be taken:

- if considered necessary by the risk assessment;
- from areas where the target control parameters are not met (ie where disinfectant levels are low or where temperatures are below 50 °C (55 °C in healthcare premises) for HWS or exceed 20 °C for cold water systems);
- from areas subject to low usage, stagnation, excess storage capacity, dead legs, excessive heat loss, crossflow from the water system or other anomaly.

2.123 In cold water systems, samples should also be taken as required:

- from the point of entry (or nearest outlet) if the water is supplied from a private water supply or where the temperature of the incoming mains supply is above 20 °C from the cold water storage tank or tanks;
- from the furthest and nearest outlet on each branch of the system (far and near sentinel outlets).

2.124 In hot water systems, samples should also be taken as required:

- from the calorifier hot water outlet and from the base of the calorifier, if it safe to do so, as some systems are under considerable pressure;
- from the furthest and nearest outlet on each branch of a single pipe system (far and near sentinel outlets);
- from the furthest and nearest outlet on each loop of a circulating system (far and near sentinel outlets).

Info box 2.5: Analysis of water samples

Analysis of water samples for legionella should be performed in UKAS-accredited laboratories with the current ISO standard methods for the detection and enumeration of legionella included within the scope of accreditation. These laboratories should also take part in a water microbiology proficiency testing scheme (such as that run by PHE or an equivalent scheme accredited to ISO 17043). Alternative quantitative testing methods may be used as long as they have been validated using ISO 17994 and meet the required sensitivity and specificity.

2.125 Table 2.2 gives guidance on action to take if legionella is found in the water system. However, for healthcare premises with vulnerable patients, the action levels and recommended actions in Table 2.3 should be considered.

Table 2.2 Action levels following legionella sampling in hot and cold water systems

| Legionella bacteria (cfu/l) | Recommended actions |
|------------------------------------|--|
| >100 cfu/l and up to 1000 | <p>Either:</p> <ul style="list-style-type: none"> ■ if the minority of samples are positive, the system should be resampled. If similar results are found again, a review of the control measures and risk assessment should be carried out to identify any remedial actions necessary or ■ if the majority of samples are positive, the system may be colonised, albeit at a low level. An immediate review of the control measures and risk assessment should be carried out to identify any other remedial action required. Disinfection of the system should be considered |
| >1000 cfu/l | The system should be resampled and an immediate review of the control measures and risk assessment carried out to identify any remedial actions, including possible disinfection of the system. Retesting should take place a few days after disinfection and at frequent intervals afterwards until a satisfactory level of control is achieved. |

Cleaning and disinfection

2.126 The risk from exposure to legionella should be controlled by keeping the water system and water in it clean and free from nutrients, including those arising from contamination and corrosion; and maintaining its cleanliness. Hardness scale may also trap nutrients, encouraging biofilm formation and so form a barrier to disinfectants.

2.127 Where necessary, hot and cold water services should be cleaned, flushed and disinfected in the following situations, as specified in BS 8558:

- on completion of a new water installation or refurbishment of a hot and cold water system;
- on installation of new components, especially those which have been pressure tested using water by the manufacturer (see the manufacturer's instructions);
- where the hot and cold water is not used for a prolonged period and has not been flushed as recommended or the control measures have not been effective for a prolonged period. For example, this could be as little as two or three weeks, but will depend on the ambient temperature, condition of the water system, potential for exposure to aerosols and the susceptibility of users considered in a specific risk assessment;
- on routine inspection of the water storage tanks, where there is evidence of significant contamination or stagnation;
- if the system or part of it has been substantially altered or entered for maintenance purposes that may introduce contamination;
- following water sampling results that indicate evidence of microbial contamination of the water system (see Table 2.2 or 2.3);
- during, or following an outbreak or suspected outbreak of legionellosis linked to the system;
- or where indicated by the risk assessment.

2.128 A suitable safe system of work, or for more complex systems, a site-specific method statement should be obtained before the start of any cleaning and/or thermal or chemical disinfection of a water system. The documentation should clearly define the process to be undertaken and should be derived from risk assessments of the typically encountered hazards, which might include:

- access/egress, storage and special site hazards, eg asbestos;
- machinery and equipment isolation;
- work in confined spaces;
- manual handling;
- work at height;
- slips, trips and falls;
- electrical equipment;
- chemical(s) to be used;
- personal protective equipment required;
- waste disposal and chemical neutralising process (a discharge permit maybe required from the water utility).

2.129 Evidence of the competence of individuals undertaking the tasks should be confirmed, indicating that the knowledge and experience of the operatives is satisfactory for undertaking the proposed work.

2.130 Disinfection of the water services when the system is offline may be by:

- **thermal disinfection**, ie by raising the HWS temperature to a level at which legionella will not survive, drawing it through to every outlet, and then

flushing at a slow flow rate to maintain the high temperature for a suitable period (the contact time). This method is only applicable to HWS and is commonly used as a rapid response. It may be less effective than chemical disinfection and may not be practicable where the hot water supply is insufficient to maintain a high temperature throughout;

- **chemical disinfection**, ie by adding an effective agent such as chlorine or chlorine dioxide, drawing it through to every outlet, then closing the outlets and allowing it to remain in contact for a suitable period (known as the contact time). This method is commonly used when it is necessary to disinfect the cold water storage tanks and the whole system.

2.131 As part of the thermal or chemical disinfection process, a service record should be kept of all work undertaken. Any items that require attention or refurbishment should be noted on the disinfection record.

2.132 To confirm effective disinfection, any required microbiological samples should be taken between two and seven days after the system is refilled. Samples taken immediately after a disinfection process may give false negative results.

Info box 2.6: Thermal and chemical disinfection

Adding disinfectant or raising the temperature above 60 °C creates a hazard to users by chemical exposure or scalding. A risk assessment must be carried out and a safe system of work put in place throughout the disinfection process. Signage and outlet warning labels should be fitted to all areas to alert occupants of the building for whom the risk is greater (such as the very young, elderly or those with sensory loss) not to use these outlets.

Thermal disinfection

2.133 Thermal disinfection of hot water services is carried out by raising the temperature of the whole contents of the calorifier and circulating water for at least an hour. Every hot water outlet throughout the system must then be flushed and, to be effective, the temperature at the calorifier should be maintained high enough to ensure that the temperature at the outlets does not fall below 60 °C. Each tap and appliance should be run sequentially for at least five minutes at the full temperature (but not necessarily at full flow), and it should be measured and recorded.

2.134 Thermal disinfection may prove to be ineffective where parts of the calorifier or water system fail to reach the required temperature for a long enough period.

Chemical disinfection

2.135 The disinfection of a water system is normally based on chlorine being dosed at 50 ppm for a minimum contact period of one hour, at the end of which the concentration should not be less than 30 ppm free residual chlorine. However, lower concentrations and longer contact times are considered acceptable, as set out in BS 8558.

2.136 Other disinfectants may be used where they are shown to be effective. Their intended application should take into account the type of system and user profile at the specified concentration levels and contact period. If the disinfectant is for use in water systems supplying wholesome water then these must comply with the requirements of The Water Supply (Water Quality) Regulations 2000, for Scotland, The Water Supply (Water Quality) (Scotland) Regulations 2001 and 2010, and for Wales, the Water Supply (Water Quality) (Wales) Regulations 2010.

2.137 After disinfection, and before the system is brought back online, the disinfectant should be completely flushed from the system. Info box 2.7 is an example of a chemical-based disinfection procedure, in this case, chlorine.

Info box 2.7: Chlorine-based disinfection

Efficacy of chlorine as a disinfectant is pH dependent and pH values in excess of 7.6 should be avoided:

- Signage and outlet warning labels should be fitted to all areas.
- A pre-disinfection should take place if the conditions within the cold water storage tank are so poor that they could adversely affect the welfare of the operators undertaking the clean.

Cleaning:

- Drain the tank to the designated drain, neutralise any residual chlorine if a pre-disinfection has been completed.
- Under normal operation, the float-operated valve is a restriction within the supply pipework and so should be operated fully open, flushing any particulate matter from the supply main.
- Physically clean the tank and associated fittings using a method that does not damage the tank coatings. (It may not be possible to clean galvanised tanks where there is evidence of corrosion).
- Remove residual sludge and water by using a wet and dry vacuum cleaner, disposing to the designated location, and rinse the tank with fresh water.

Disinfection:

- Refill the tank with fresh make-up water, isolate from the mains supply and add the required quantity of disinfectant using the turbulence of filling to distribute it.
- Test the contents of the tank to confirm the required level of disinfectant has been achieved using a quantitative test kit.
- Draw the disinfecting solution through to the water heaters and subsequently to all outlets fed from the system.
- Test key far sentinel outlets to ensure the required concentration is reached.
- Test all other outlets with a fast and simple test showing the presence or absence of disinfectant.
- Top up the tank with fresh water and sufficient disinfectant to bring the concentration back up to target levels.
- Leave the system for the designated contact period.
- Retest key outlets at the end of the contact period to confirm that satisfactory disinfectant levels are achieved. Check concentrations at intervals during the contact period and restore the disinfectant levels if they decline. If the concentration should fall below the minimum, restart the process.
- Add a neutralising agent to the tank and ensure there is no disinfectant before flushing through to the water heaters.
- Draw neutralised water through to all outlets, measuring to ensure the absence of disinfectant.
- Remove signage and outlet warning labels.
- If the water is for non-potable use, the tank inlet can be reopened as long as the subsequent refilling dilutes any neutralising product to insignificant levels. If the tank supplies wholesome water to outlets, it should be fully drained, refilled with fresh water and flushed with water free from neutralising agent.

Shared premises and residential accommodation: Landlords

Residential accommodation: Landlords

2.138 Landlords who provide residential accommodation, as the person in control of the premises or responsible for the water systems in their premises, have a legal duty to ensure that the risk of exposure of tenants to legionella is properly assessed and controlled. This duty extends to residents, guests, tenants and customers. They can carry out a risk assessment themselves if they are competent, or employ somebody who is.

2.139 Where a managing (or letting) agent is used, the management contract should clearly specify who has responsibility for maintenance and safety checks, including managing the risk from legionella. Where there is no contract or agreement in place or it does not specify who has responsibility, the duty is placed on whoever has control of the premises and the water system in it, and in most cases, this will be the landlord themselves.

2.140 All water systems require a risk assessment but not all systems require elaborate control measures. A *simple* risk assessment may show that there are no real risks from legionella, but if there are, implementing appropriate measures will prevent or control these risks. The law requires simple, proportionate and practical actions to be taken, including identifying and assessing sources of risk, managing the risk, preventing or controlling the risk; and periodically checking that any control measures are effective.

2.141 For most residential settings, the risk assessment may show the risks are low, in which case no further action may be necessary, eg housing units with small domestic-type water systems where water turnover is high. If the assessment shows the risks are insignificant and are being properly managed to comply with the law, no further action may be required, but it is important to review the assessment periodically in case anything changes in the system. However, the frequency of inspection and maintenance will depend on the system and the risks it presents.

2.142 Simple control measures can help manage the risk of exposure to legionella and should be maintained, such as:

- flushing out the system before letting the property;
- avoiding debris getting into the system (eg ensure the cold water tanks, where fitted, have a tight-fitting lid);
- setting control parameters (eg setting the temperature of the calorifier to ensure water is stored at 60 °C);
- making sure any redundant pipework identified is removed;
- advising tenants to regularly clean and disinfect showerheads.

2.143 Landlords should inform tenants of the potential risk of exposure to legionella and its consequences and advise on any actions arising from the findings of the risk assessment, where appropriate. Tenants should be advised to inform the landlord if the hot water is not heating properly or if there are any other problems with the system, so that appropriate action can be taken.

2.144 The risk may increase where the property is unoccupied for a short period. It is important that water is not allowed to stagnate within the water system and so

dwellings that are vacant for extended periods should be managed carefully. As a general principle, outlets on hot and cold water systems should be used at least once a week to maintain a degree of water flow and minimise the chances of stagnation. To manage the risks during non-occupancy, consider implementing a suitable flushing regime or other measures, such as draining the system if the dwelling is to remain vacant for long periods.

2.145 Where there are difficulties gaining access to occupied housing units, appropriate checks can be made by carrying out inspections of the water system, eg when undertaking mandatory visits such as gas safety checks or routine maintenance visits.

2.146 It may be impractical to risk assess every individual residential unit, eg where there are a significant number of units under the control of the landlord, such as Housing Associations or Councils. In such cases, a representative proportion of the premises for which they have responsibility should initially be assessed, on the basis of similar design, size, age and water supply, with the entire estate eventually assessed on a rolling programme of work.

Shared premises

2.147 Those who have, to any extent, control of premises for work-related activities or the water systems in the building, have a responsibility to those who are not their employees, but who use those premises. A suitable and sufficient assessment must be carried out to identify, assess and properly control the risk of exposure to legionella bacteria from work activities and the water systems on the premises.

2.148 In estate management, it is increasingly common for there to be several dutyholders in one building. In such cases, duties may arise where persons or organisations have clear responsibility through an explicit agreement, such as a contract or tenancy agreement.

2.149 The extent of the duty will depend on the nature of that agreement. For example, in a building occupied by one leaseholder, the agreement may be for the owner or leaseholder to take on the full duty for the whole building or to share the duty. In a multi-occupancy building, the agreement may be that the owner takes on the full duty for the whole building. Alternatively, it might be that the duty is shared where, eg the owner takes responsibility for the common parts while the leaseholders take responsibility for the parts they occupy. In other cases, there may be an agreement to pass the responsibilities to a managing agent. Where a managing agent is used, the management contract should clearly specify who has responsibility for maintenance and safety checks, including managing the risk from legionella.

2.150 Where there is no contract or tenancy agreement in place or it does not specify who has responsibility, the duty is placed on whoever has control of the premises, or part of the premises.

Info box 2.8: Example of shared premises and responsibilities

A managing agent looks after a commercial building and provides mains hot and cold water services to three tenanted areas. By contract, the managing agent has a responsibility to risk assess and ensure the safety of the water from the incoming mains up to where the water enters the part of the building the tenant occupies. The tenants have the responsibility to do the same from the point at which it enters their premises. All parties should take steps to ensure that each is fulfilling the legal responsibilities for the parts of the building over which they have control. The managing agent should take steps, eg by contractual arrangements, to ensure that tenants are complying with their duties because if the tenant's water system becomes contaminated with legionella bacteria it may act as a reservoir, seeding it back down into the systems for which the managing agent has responsibility.

2.151 Where employers share premises or workplaces, the Management of Health and Safety at Work Regulations 1999, regulation 11 (see www.hse.gov.uk/risk for more information) requires that they cooperate with each other to ensure their respective obligations are met. For example, with regard to the management of the water systems in the building, routine monitoring by any party may indicate possible problems within the building water system. This information should be communicated to enable cooperation and coordination, particularly where another party may be able to help or are contributing to the risk. In such cases, a joint plan can be formulated and appropriate remedial action taken.

Special considerations for healthcare and care homes

2.152 Legionnaires' disease is a potentially fatal form of pneumonia and everyone is susceptible to infection, but there are a number of factors that increase susceptibility, including increasing age (particularly those over 50 years); those with existing respiratory diseases or certain illnesses and conditions such as cancer, diabetes, kidney disease; alcoholics; smokers; and those with an impaired immune system.

2.153 Special consideration should be given to patients or occupants within healthcare premises, residential or care homes where they are exposed to water systems and a range of potential sources of waterborne infection, eg patient ventilation humidification systems that are not necessarily present in a non-healthcare setting.

2.154 This guidance gives information on special considerations where there are susceptible individuals but should be applied proportionately, eg in an acute hospital setting where there are likely to be a larger number of susceptible patients at risk of infection, the organisation may need to follow most or all aspects of the guidance. However, in other settings where there may be less susceptible residents, a local risk assessment will help determine which aspects of this guidance are relevant. Further guidance is also available for care settings in *Health and safety in care homes*.

2.155 Appendix 2.1 gives information on what the risk assessment should consider and should take into account the susceptibility of 'at risk' patients. Both the relative risks of legionella infection, scalding and any additional measures that may be required to effectively manage those risks should be considered.

Info box 2.9: Patients in augmented care units

Water systems: Health Technical Memorandum HTM 04-01 published by the Department of Health (England) advises that it may be preferable to provide separate small systems, with independent supply and local heating sources for patients in augmented care units (ie where medical/nursing procedures render the patients susceptible to invasive disease from environmental and opportunistic pathogens and include patients).

2.156 Hot and cold water systems should be maintained to keep cold water, where possible, at a temperature below 20 °C, and stored hot water at 60 °C and distributed so that it reaches the outlets at 55 °C within one minute. The minimum temperature at the most distant point should be 55 °C, ie the temperature of the hot water as it returns to the calorifier should not fall below 50 °C. Circulation of cold water and refrigeration should only be considered in specialist units where people are at particular risk as a result of immunological deficiency, eg transplant units. All other uses of water should also be considered and appropriate action taken, as these may not be appropriate in an augmented care setting (eg use of ice machines, drinking water fountains, bottled water dispensers etc). Where required, they should be considered as part of the risk assessment as there is an increased risk in compromised patients for legionella infection to occur following aspiration of ingested water contaminated with legionella.

2.157 For healthcare premises, the Department of Health (England) *Health Technical Memorandum 04-01: Addendum* advises the formation of Water Safety Groups (WSG) who develop the Water Safety Plan (WSP). Although the addendum focuses on specific additional measures to control or minimise the risk of *Pseudomonas aeruginosa* in augmented care units, it also has relevance to other waterborne pathogens including legionella. Info box 2.10 provides a brief summary of what constitutes a WSP and WSG. While not statutory under health and safety legislation, the formation of a WSG

Info box 2.10: Water Safety Groups and Water Safety Plans

Water Safety Group – The WSG is a multidisciplinary group formed to undertake the commissioning, development, implementation and review of the WSP. The aim of the WSG is to ensure the safety of all water used by patients/residents, staff and visitors, to minimise the risk of infection associated with water, including legionella. It provides a forum in which people with a range of competencies can be brought together to share responsibility and take collective ownership for ensuring it identifies microbiological hazards, assesses risks, identifies and monitors control measures and develops incident protocols.

As per the addendum, the roles, responsibility and accountability of the WSG should be defined. The chair of the WSG is a local decision but the Director of Infection Prevention and Control (DIPC) may normally lead the group. The WSG may typically comprise personnel who:

- are familiar with all water systems and associated equipment in the building(s) and the factors which may increase risk of legionella infection, ie the materials and components, the types of use and modes of exposure, together with the susceptibility to infection of those likely to be exposed;
- have knowledge of the particular vulnerabilities of the 'at risk' population within the facility and, as part of its wider remit, the WSG should include representatives from areas where water may be used in therapies, medical treatments or decontamination processes (eg hydrotherapy, renal, sterile services) where exposure to aerosols may take place.

Water Safety Plans – The WSP is a risk management approach to the microbiological safety of water that establishes good practices in local water usage, distribution, supply and controls. It will identify potential microbiological hazards, consider practical aspects and detail appropriate control measures. WSPs are working documents that need to be kept up to date and reviewed to ensure the adequate assessment and control of the risks from a wide range of waterborne pathogens, including legionellae in healthcare and care home settings.

WSPs include the need to:

- assess the risks which may be posed to patients (including those with particular susceptibility), employees and visitors;
- put into place appropriate management systems to ensure the risks are adequately controlled;
- ensure there are supporting programmes, including communication, training and competency checks.

The risks from legionellosis should form an integral part of any WSP, ensuring that there is adequate documentation and communication with the WSG both for normal operation of the systems and following incidents, eg when there have been failures in controls, equipment, cases of illness associated with the system etc.

and implementation of a WSP complements the requirements in the Approved Code of Practice *Legionnaires' disease. The control of legionella bacteria in water systems* for an adequate assessment of risk and the formulation and implementation of an effective written control scheme to minimise the risks from exposure to legionellosis. This should be applied proportionately depending on the setting.

Monitoring for legionella

2.158 The strategy for monitoring for legionella should identify patients at increased risk, eg in areas where immuno-compromised patients are present, such as oncology, haematology and transplant units. The strategy should identify all components of the recirculating water system in those units and representative outlets where water samples can be taken and results interpreted to determine the level of colonisation.

2.159 Legionella monitoring should be carried out where there is doubt about the efficacy of the control regime or where recommended temperatures, disinfectant concentrations or other precautions are not being consistently achieved throughout the system. Where considered appropriate, monitoring for legionella should be carried out in line with BS 7592 *Sampling for legionella in water and related materials*. See paragraphs 2.119–2.125 for further information.

2.160 Monitoring results to determine appropriate action levels, depending on whether colonisation is local to an outlet or more widespread within the water system, should be interpreted by a competent person. To establish if the circulating hot water or the distributed cold water is under control, samples should be taken from separate hot and cold water outlets which are not blended. This will ensure the sample is representative of the water flowing around the system and not just of the area downstream of the mixing valve. Monitoring of hot and cold water systems where TMVs are fitted needs careful consideration to ensure the results are interpreted in the context of the conditions in place at the time of sampling.

2.161 Table 2.3 describes the action levels in healthcare premises with susceptible patients at an increased risk of exposure. Whereas, in a general healthcare setting where legionella monitoring is considered appropriate, Table 2.2 describes the actions to be taken.

2.162 Where considered necessary for ongoing patient management, POU filters should be used primarily as a temporary control measure while a permanent safe engineering solution is developed, although long-term use of such filters may be required in some cases.

Table 2.3 Actions to be taken following legionella sampling in hot and cold water systems in healthcare premises with susceptible patients

| Legionella bacteria (cfu/l) | Recommended actions |
|------------------------------------|--|
| Not detected or up to 100 cfu/l | In healthcare, the primary concern is protecting susceptible patients, so any detection of legionella should be investigated and, if necessary, the system resampled to aid interpretation of the results in line with the monitoring strategy and risk assessment |
| >100 cfu/l and up to 1000 cfu/l | Either: <ul style="list-style-type: none"> ■ if the minority of samples are positive, the system should be resampled. If similar results are found again, review the control measures and risk assessment to identify any remedial actions necessary or ■ if the majority of samples are positive, the system may be colonised, albeit at a low level. An immediate review of control measures and a risk assessment should be carried out to identify any other remedial action required. Disinfection of the system should be considered |
| >1000 cfu/l | The system should be resampled and an immediate review of the control measures and risk assessment carried out to identify any remedial actions, including possible disinfection of the system. Retesting should take place a few days after disinfection and at frequent intervals thereafter until a satisfactory level of control is achieved |

Scalding

2.163 There is a risk of scalding where the water temperature at the outlet is above 44 °C. In certain facilities with ‘at risk’ patients this is especially so where there is whole body immersion in baths and showers of vulnerable patients, including the very young, elderly people, and people with disabilities or those with sensory loss who may not be able to recognise high temperatures and respond quickly. Where there are vulnerable individuals and whole body immersion, testing of outlet temperatures using a thermometer can provide additional reassurance.

2.164 The potential scalding risk should be assessed and controlled in the context of the vulnerability of those being cared for. The approach will depend on the needs and capabilities of patients or residents. For most people, the scalding risk is minimal where water is delivered up to 50 °C at hand washbasins and using hot water signs may be considered sufficient, where a TMV is not fitted. However, where vulnerable people are identified and have access to baths or showers and the scalding risk is considered significant, TMV Type 3 (TMV3) are required. Further advice on safe bathing can be found in the UK Homecare Association (UKHCA) guidance *Controlling scalding risks from bathing and showering*.³⁴

2.165 Where the risk assessment considers fitting TMVs appropriate, the strainers or filters should be inspected, cleaned, descaled and disinfected annually or on a frequency defined by the risk assessment, taking account of any manufacturers’ recommendations. To maintain protection against scald risk, TMVs require regular routine maintenance carried out by competent individuals in accordance with the manufacturer’s instructions. HSE’s website provides further information at www.hse.gov.uk/healthservices/scalding-burning.htm.

Info box 2.11: Use of TMV Type 3 (TMV3)

TMV3 meets the requirements of the NHS Estates Model Engineering Specification *Thermostatic mixing valves (healthcare premises)*³⁵ and cannot be overridden by the user. In reality, the chances of a severe scald from a washbasin tap are low and the need for a TMV3 on a hand washbasin should be assessed against the need for legionella control. It is important that a documented maintenance schedule is followed and the TMVs maintained to the standard recommended by the manufacturer.

Flushing

2.166 The risk from legionella is increased in peripheral parts of the hot and cold water system where there are remote outlets such as hand washbasins, and dead legs. Where reasonably practicable, dead legs should be removed or the risk minimised by regular use of these outlets. Where outlets in healthcare facilities with susceptible patients are not in regular use the risk assessment may indicate the need for more frequent flushing, ie twice weekly and water draw off should form part of the daily cleaning process to achieve temperature control for both hot and cold water and/or biocide flow through.

2.167 In circumstances where there has been a lapse in the flushing regime, the stagnant and potentially contaminated water from within the shower or tap and associated dead leg should be purged to drain without discharge of aerosols before the appliance is used.

2.168 For comprehensive advice about the legal requirements, design applications, maintenance and operation of hot and cold water supply, storage and distribution systems in healthcare premises, refer to *Water systems: Health Technical Memorandum 04-01* (for England and Wales), or to *Scottish Health Technical Memorandum 04-01* (for Scotland).

Appendix 2.1 Legionella risk assessment

1 It is a legal duty to carry out an assessment to identify and assess whether there is a risk posed by exposure to legionella from the hot and cold water system or any work associated with it.

2 The risk assessment should consider all aspects of operation of the hot and cold water systems and while there will be common factors, the individual characteristics of each system should be taken into account. Site personnel who manage the systems to determine current operational practice should be consulted. The commissioning, decommissioning, periods of operation, maintenance, treatment and subsequent management of each individual aspect of operation will require review and validation to ensure site procedures are effective.

3 The checklist below gives the most common key requirements when assessing risk associated with a hot and cold water system based on mechanical, operational, chemical and management aspects:

- details of management personnel who play an active role in the risk management process, to include names, job titles and contact information for:
 - the dutyholder;
 - the appointed responsible person (s), including deputies;
 - service providers, eg water treatment suppliers, cleaning and disinfection service providers;
- an assessment of the competence of those associated with risk management, including their training records;
- identification of roles and responsibilities, to include employees, contractors and consultants;
- a check to confirm that consideration was given to preventing the risk by elimination or substitution before implementing appropriate control measures;
- the scope of the assessment, ie the details and entirety of the plant being assessed;
- assessment of the validity of the schematic diagram which should include all parts of the system where water may be used or stored;
- details of the design of the system, including an asset register of all associated plant, pumps, strainers, outlets and other relevant items;
- assessment of the potential for the water system to become contaminated with legionella and other material;
- details of any water pre-treatment process;
- assessment of the potential for legionella to grow within the system and effectiveness of control measures:
 - chemical and physical water treatment measures;
 - disinfection and cleaning regimes;
 - remedial work and maintenance;
- evidence of corrective actions being implemented;
- evidence of proactive management and follow-up of previous assessment recommendations or identified remedial actions;
- evidence of the competence of those involved in control and monitoring activities;
- a review of the legionella control scheme, including management procedures and site records or logbooks, which include:
 - system maintenance records;
 - routine monitoring data;

- water treatment and service reports;
- cleaning and disinfection records;
- legionella and other microbial analysis results.

The following specific considerations should also be assessed for hot and cold water systems:

- quality of the supply water – where this is not wholesome, additional risks and measures to mitigate the risk must be included in the risk assessment process;
- examination of tanks for configuration, flow pattern, protection against contamination, materials of construction, condition, temperature, size in comparison to water consumption and cleanliness or contamination;
- any points in the system where there is a possibility of low or no flow, such as blind ends, dead legs and little used outlets;
- any parts of the CWDS susceptible to heat gain to an extent that could support the growth of legionella;
- any parts of the system with low water throughput including, eg low-use fittings in unoccupied areas or oversized tanks that may lead to stagnation;
- any parts of the system which are configured in parallel with others and where the water flow could be unbalanced;
- hot water system return pipes – stagnation often occurs, particularly at points furthest away from the water heater, where circulation has failed and the hot water has cooled;
- timely, appropriate remedial action to poor temperature or monitoring results and using this as an indicator of the effectiveness and adequacy of the management controls in place.

The assessment should include recommendations for remedial actions for controlling legionella where necessary and identify who will undertake the actions. Actions should be prioritised and a review date set for determining completion of these tasks.

See BS 8580³⁶ for more information.

Appendix 2.2 Legionella written control scheme

1 The risk from exposure will normally be controlled by measures which do not allow the proliferation of legionella bacteria in the system. Once the risk is identified and assessed, a written control scheme should be prepared, implemented and properly managed for preventing or controlling legionella.

2 The scheme should specify the various control measures, how to use and carry out those measures, describe the water treatment regimes and the correct operation of the water system. The scheme should be specific and tailored to the system covered by the risk assessment. Along with the guidance in this document, this appendix summarises the information to include in a legionella written control scheme, ie:

- purpose;
- scope;
- risk assessment;
- management structure:
 - dutyholder;
 - responsible person(s) and communication pathways;
 - training;
 - allocation of responsibilities, ie to the dutyholder, responsible person(s) and water treatment service provider;
- up-to-date schematic plan showing the layout of the system(s) and its location within and around the premises – this should identify piping routes, storage and header tanks, calorifiers and relevant items of plant, especially water softeners, filters, strainers, pumps and all water outlets;
- the correct and safe operation of the system;
- precautions in place to prevent or minimise risk associated with the system;
- analytical tests, including microbiological testing, other operational checks, inspections and calibrations to be carried out, their frequency and any resulting corrective actions;
- remedial action to be taken in the event that the scheme is shown not to be effective, including control scheme reviews and any modifications made;
- health and safety information, including details on storage, handling, use and disposal of any chemical used in both the treatment of the system and testing of the system water;
- incident plan, which covers the following situations:
 - major plant failure, eg chemical system failure;
 - very high levels or repeat positive water analyses for legionella;
 - an outbreak of legionellosis, suspected or confirmed as being centred at the site;
 - an outbreak of legionellosis, the exact source of which has yet to be confirmed, but which is believed to be centred in an area which includes the site.

Appendix 2.3 Action to take if there is an outbreak of legionellosis

- 1 In England and Wales, legionnaires' disease is notifiable under the Health Protection (Notification) Regulations 2010³⁷ and in Scotland under the Public Health (Notification of Infectious Diseases) (Scotland) Regulations 1988.³⁸ Under these Regulations, human diagnostic laboratories must notify Public Health England (PHE), Public Health Wales (PHW) or Health Protection Scotland (HPS) (see 'Further sources of advice') of microbiologically confirmed cases of legionnaires' disease.
- 2 An outbreak is defined as two or more cases where the onset of illness is closely linked in time (weeks rather than months) and where there is epidemiological evidence of a common source of infection, with or without microbiological evidence. An incident/outbreak control team should always be convened to investigate outbreaks. It is the responsibility of the Proper Officer to declare an outbreak. The Proper Officer, appointed by the Local Authority, is usually a Consultant in Communicable Diseases Control (CCDC) in England and Wales, or the Consultant in Public Health Medicine (CPHM) in Scotland. If there are suspected cases of the disease, medical practitioners must notify the Proper Officer in the relevant local authority.
- 3 Local Authorities will have jointly established incident plans to investigate major outbreaks of infectious diseases, including legionellosis, and it is the Proper Officer who activates these and invokes an Outbreak Committee, whose primary purpose is to protect public health and prevent further infection.
- 4 HSE or local Environmental Health Officers may be involved in the investigation of outbreaks, their aim being to pursue compliance with health and safety legislation. The local authority, Proper Officer or EHO acting on their behalf will make a visit for public health reasons, often with the relevant officer from the enforcing authorities (ie HSE or the local authority) for health and safety reasons. Any infringements of relevant legislation may be subject to a formal investigation by the appropriate enforcing authority.
- 5 There are published guidelines (by PHE, PHW and HPS) for the investigation and management of incidents, clusters, and outbreaks of legionnaires' disease in the community.
- 6 These are, for England and Wales, *Guidance on the Control and Prevention of Legionnaires' Disease in England*³⁹ and for Scotland, *Guidelines on Management of Legionella Incidents, Outbreaks and Clusters in the Community*.⁴⁰
- 7 If a water system is implicated in an outbreak of legionnaires' disease, emergency treatment of that system should be carried out as soon as possible. This will usually involve the processes detailed in paragraphs 2.124–2.135.

Appendix 2.4 Example of sentinel points in a simple hot water system (HWS)

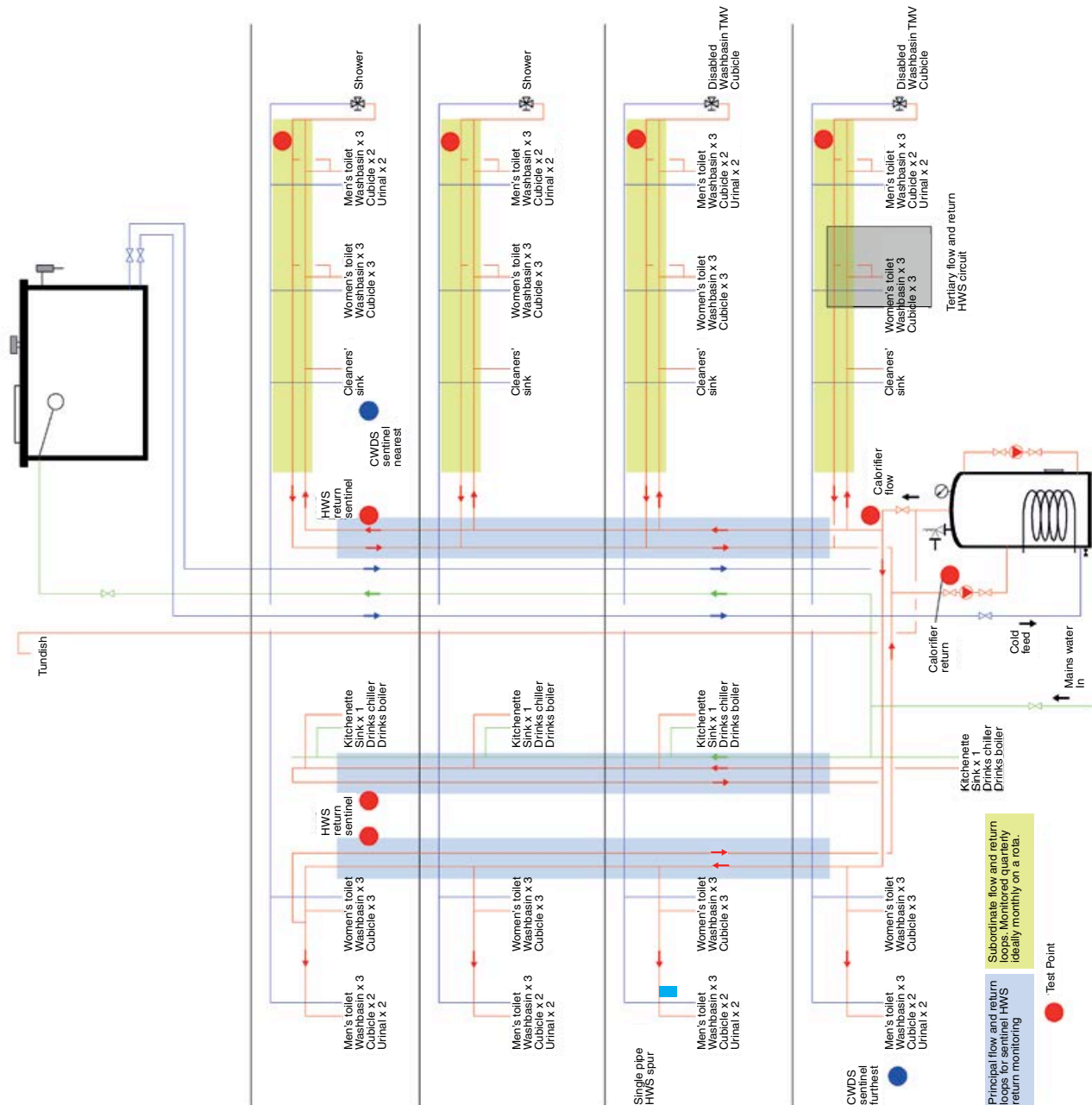

Appendix 2.5 Example of sentinel points in a complex hot water system (HWS)

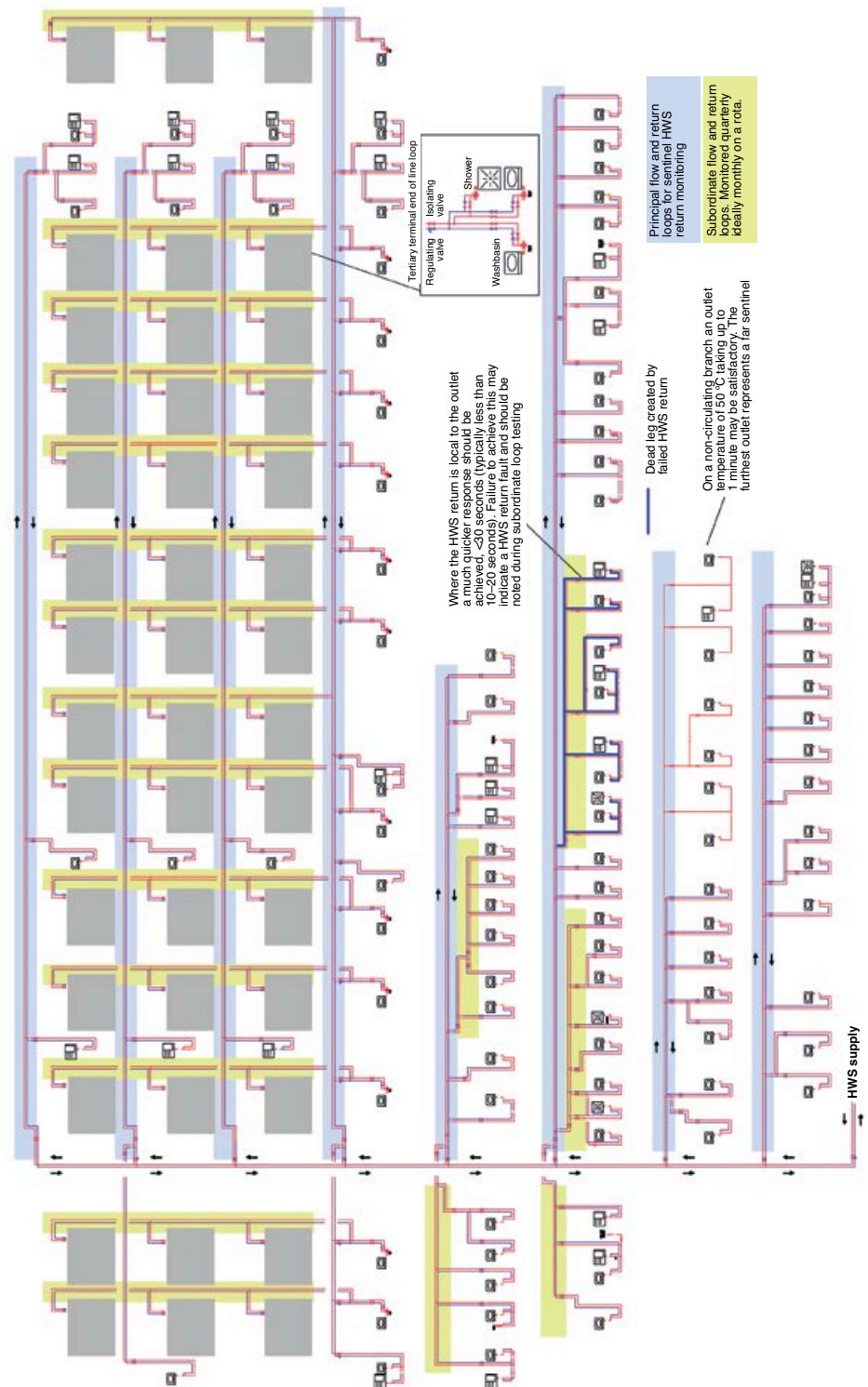

Glossary

aerosol a suspension in a gaseous medium of solid particles, liquid particles or solid and liquid particles having a negligible falling velocity. In the context of this document, it is a suspension of particles which may contain legionella with a typical droplet size of <math><5\ \mu\text{m}</math> that can be inhaled deep into the lungs.

algae a small, usually aquatic, plant that requires light to grow.

bacteria (singular bacterium) a microscopic, unicellular (or more rarely multicellular) organism.

biocide a substance which kills microorganisms.

biofilm a community of bacteria and other microorganisms embedded in a protective layer with entrained debris, attached to a surface.

calorifier an apparatus used for the transfer of heat to water in a vessel, the source of heat being contained within a pipe or coil immersed in the water.

chlorine an element used as a biocide and for disinfection.

chlorine dioxide a compound used as a biocide.

cold water service installation of plant, pipes and fitting in which cold water is stored, distributed and subsequently discharged.

contact time the time a chemical is retained in the system.

corrosion inhibitors chemicals which protect metals by: passivating the metal by the promotion of a thin metal oxide film (anodic inhibitors); or physically forming a thin barrier film by controlled deposition (cathodic inhibitors).

dead end/blind end a length of pipe closed at one end through which no water passes.

dead leg a length of water system pipework leading to a fitting through which water only passes infrequently when there is draw off from the fitting, providing the potential for stagnation.

disinfection the reduction of the number of microorganisms to safe levels by either chemical or non-chemical means (eg biocides, heat or radiation).

distribution circuit pipework which distributes water from hot or cold water plant to one or more fittings/appliances.

domestic water hot and cold water intended for drinking, washing, cooking, food preparation or other domestic purposes.

fouling organic growth or other deposits on heat transfer surfaces causing loss in efficiency.

hot water service installation of plant, pipes and fittings in which water is heated, distributed and subsequently discharged (not including cold water feed tank or cistern).

legionnaires' disease a form of pneumonia caused by bacteria of the genus legionella.

legionella (plural legionellae) a bacterium (or bacteria) of the genus legionella.

legionellosis any illness caused by exposure to legionella.

mg/l (milligrams per litre) a measure of dissolved substances given as the number of parts there are in a million parts of solvent. It is numerically equivalent to ppm (parts per million) with respect to water.

microorganism an organism of microscopic size, including bacteria, fungi and viruses.

neonates newborn children.

nutrient a food source for microorganisms.

pasteurisation heat treatment to destroy microorganisms, usually at high temperature.

pH the logarithm of the reciprocal of the hydrogen ion concentration in water, expressed as a number between 0 and 14 to indicate how acidic or alkaline the water is. Values below 7 are increasingly acidic, 7 is neutral, and values higher than 7 are progressively alkaline. However, acidity and alkalinity are not proportional to pH.

planktonic free-floating microorganisms in an aquatic system.

point of use (POU) filters a filter with a maximal pore size of 0.2 µm applied at the outlet, which removes bacteria from the water flow.

ppm (parts per million) a measure of dissolved substances given as the number of parts there are in a million parts of solvent. It is numerically equivalent to milligrams per litre (mg/l) with respect to water.

risk assessment identifying and assessing the risk from legionellosis from work activities and water sources on premises and determining any necessary precautionary measures.

scale inhibitors chemicals used to control scale. They function by holding up the precipitation process and/or distorting the crystal shape, thus preventing the build-up of a hard adherent scale.

sentinel taps for hot water services – the first and last taps on a recirculating system. For cold water systems (or non-recirculating HWS), the nearest and furthest taps from the storage tank. The choice of sentinel taps may also include other taps which represent parts of the recirculating system where monitoring can aid control.

sero-group a sub-group of the main species.

sessile aquatic microorganisms adhering to a surface, normally as part of a biofilm.

shunt pump a circulation pump fitted to hot water service/plant to overcome the temperature stratification of the stored water.

slime a mucus-like exudate that covers a surface produced by some microorganisms.

sludge a general term for soft mud-like deposits found on heat transfer surfaces or other important sections of a cooling system. Also found at the base of calorifiers and cold water storage tanks.

stagnation the condition where water ceases to flow and is therefore liable to microbiological growth.

strainers coarse filters usually positioned upstream of a sensitive component, such as a pump control valve or heat exchanger, to protect it from debris.

thermal disinfection heat treatment to disinfect a system.

thermostatic mixing valve a mixing valve in which the temperature at the outlet is pre-selected and controlled automatically by the valve.

total viable counts (TVC) the total number of culturable bacteria (per volume or area) in a given sample (does not include legionella).

wholesome water water supplied for such domestic purposes as cooking, drinking, food preparation or washing; or supplied to premises in which food is produced

References

- 1 Legionnaires' disease: The control of legionella bacteria in water systems. Approved Code of Practice L8 (Fourth edition) HSE Books 2013 www.hse.gov.uk/pubns/books/l8.htm
- 2 *Health and Safety at Work etc Act 1974* (c 37) The Stationery Office 1974 ISBN 978 0 10 543774 1
- 3 *Hazardous substances at work: A brief guide to COSHH* Leaflet INDG136(rev5) HSE Books 2012 www.hse.gov.uk/pubns/indg136.htm
- 4 *The Notification of Cooling Towers and Evaporative Condensers Regulations 1992* SI 1992/2225 The Stationery Office
- 5 *Reporting accidents and incidents at work: A brief guide to the Reporting of Injuries, Diseases and Dangerous Occurrences Regulations (RIDDOR)* Leaflet INDG453(rev1) HSE Books 2013 www.hse.gov.uk/pubns/indg453.htm
- 6 *Consulting workers on health and safety. Safety Representatives and Safety Committees Regulations 1977 (as amended) and Health and Safety (Consultation with Employees) Regulations 1996 (as amended). Approved Codes of Practice and guidance L146* (Second edition) HSE Books 2012 ISBN 978 0 7176 6461 0 www.hse.gov.uk/pubns/books/l146.htm
- 7 BS 8580 *Water quality. Risk assessments for Legionella control. Code of practice* British Standards Institution
- 8 *Guide to risk assessment for water services* The Water Management Society www.wmsoc.org.uk/publication.html
- 9 *A Recommended Code of Conduct for Service Providers* The Legionella Control Association 2013 www.legionellacontrol.org.uk.
- 10 *Water Fittings and Materials Directory* Water Regulations Advisory Scheme www.wras.co.uk/Directory
- 11 BS 6920-2-1+A3 *Suitability of non-metallic products for use in contact with water intended for human consumption with regard to their effect on the quality of the water. Methods of test* British Standards Institution
- 12 *Health and safety in care homes* HSG220 HSE Books 2001 ISBN 978 0 7176 2082 1 www.hse.gov.uk/pubns/books/hsg220.htm
- 13 *Water systems: Health Technical Memorandum 04-01: The control of Legionella, hygiene, 'safe' hot water, cold water and drinking water systems* Department of Health 2006
- 14 *Scottish Health Technical Memorandum 04-01* Health Facilities Scotland www.hfs.scot.nhs.uk/publications-1/engineering/shtm-04-01/
- 15 *Water Supply (Water Fitting) Regulations 1999* SI 1148/1999 The Stationery Office
- 16 *Water Byelaws 2004* Scottish Water www.scottishwater.co.uk

17 BS 3198 *Specification for copper hot water storage combination units for domestic purposes* British Standards Institution

18 *Managing health and safety in construction. Construction (Design and Management) Regulations 2007. Approved Code of Practice L144* HSE Books 2007 ISBN 978 0 7176 6223 4 www.hse.gov.uk/pubns/books/l144.htm

19 Approved Documents for Building Regulations in England and Wales: www.planningportal.gov.uk/buildingregulations/
Approved Documents for Building Regulations in Scotland:
www.scotland.gov.uk/Topics/Built-Environment/Building/Building-standards

20 *The Private Water Supplies Regulations 2009* SI 3101/2009
The Stationery Office

21 *The Private Water Supplies (Wales) Regulations 2010* Welsh SI 66/2010
The Stationery Office

22 *The Private Water Supplies (Scotland) Regulations 2006* SSI 209/2006
The Stationery Office

23 BS EN 806 (Parts 1–5) *Specifications for installations inside buildings conveying water for human consumption* British Standards Institution

24 BS 8558 *Guide to the design, installation, testing and maintenance of services supplying water for domestic use within buildings and their curtilages* British Standards Institution

25 *Guide G: Public Health Engineering* CIBSE www.cibse.org

26 *The Water Supply (Water Quality) Regulations 2001* SI 3911/2001
The Stationery Office

27 *Water Industry Act 1991* The Stationery Office 1991 ISBN 978 0 10 545691 9

28 *Water (Scotland) Act 1980* The Stationery Office 1980 ISBN 978 0 10 544580 7

29 *The Water Supply (Water Quality) (Wales) Regulations 2010* SSI 994/2010
The Stationery Office

30 *The Water Supply (Water Quality) (Scotland) Regulations 2001* SSI 207/2001
The Stationery Office

31 *The Water Supply (Water Quality) (Scotland) Regulations 2010* SSI 95/2010
The Stationery Office

32 BS EN 12671 *Chemicals used for treatment of water intended for human consumption. Chlorine dioxide generated in situ* British Standards Institution

33 BS 7592 *Sampling for Legionella organisms in water systems. Code of Practice* British Standards Institution

34 *Controlling scalding risks from bathing and showering* United Kingdom Homecare Association (UKHCA) www.ukhca.co.uk

35 *Thermostatic mixing valves (healthcare premises)* NHS Model Engineering Specifications D08 NHS 1997

36 BS 8580 *Water quality. Risk assessments for Legionella control. Code of practice* British Standards Institution

37 *The Health Protection (Notification) Regulations 2010* SI 659/2010
The Stationery Office

38 *The Public Health (Notification of Infectious Diseases) (Scotland) Regulations 1988* SSI1550/1988 The Stationery Office

39 *Guidance on the Control and Prevention of Legionnaires' Disease in England*
Health Protection Agency 2010 www.hpa.org.uk

40 *Guidelines on Management of Legionella Incidents, Outbreaks and Clusters in the Community* Health Protection Agency Scotland 2009 www.hpa.scot.nhs.uk

Further sources of advice

United Kingdom Accreditation Service (UKAS), 21–47 High Street, Feltham, Middlesex TW13 4UN www.UKAS.com

Public Health England (PHE)
www.gov.uk/government/organisations/public-health-england

Public Health Wales (PHW) www.publichealthwales.wales.nhs.uk

Health Protection Scotland (HPS) www.hps.scot.nhs.uk

Acknowledgements

HSE thanks the following organisations for providing representatives with technical expertise, which was used when preparing the technical guidance that appears in this publication: Legionella Control Association (Howard Barnes, Robert McLeod-Smith); British Association for Chemical Specialities (Tim Parkinson, Geoff Walker, John Smith); Water Management Society (John Lindeman, Alan Elsworth, Mike Hunter, Graham Thompson, Giles Green, Alan Greaves, Susanne Lee); and Dr Tom Makin.

Further information

For information about health and safety, or to report inconsistencies or inaccuracies in this guidance, visit www.hse.gov.uk/. You can view HSE guidance online and order priced publications from the website. HSE priced publications are also available from bookshops.

This guidance is issued by the Health and Safety Executive. Following the guidance is not compulsory, unless specifically stated, and you are free to take other action. But if you do follow the guidance you will normally be doing enough to comply with the law. Health and safety inspectors seek to secure compliance with the law and may refer to this guidance.

British Standards can be obtained in PDF or hard copy formats from BSI:
<http://shop.bsigroup.com> or by contacting BSI Customer Services for hard copies only Tel: 0845 086 9001 email: cservices@bsigroup.com.

The Stationery Office publications are available from The Stationery Office, PO Box 29, Norwich NR3 1GN Tel: 0870 600 5522 Fax: 0870 600 5533 email: customer.services@tso.co.uk Website: www.tsoshop.co.uk/ (They are also available from bookshops.) Statutory Instruments can be viewed free of charge at www.legislation.gov.uk/, where you can also search for changes to legislation.

This document is available at www.hse.gov.uk/pubns/priced/hsg274part2.pdf.

© *Crown copyright* If you wish to reuse this information visit www.hse.gov.uk/copyright.htm for details. First published 04/14.